

BUFFALO FORGE

THERMAPREMIUM STEEL 8' ENTRY DOORS



GLASS★CRAFT®
DOOR COMPANY



BUFFALO FORGE THERMAPREMIUM By GlassCraft

More than 40 years of unique doors...

Founded in 1977, GlassCraft has built a reputable brand focused on craftsmanship and innovation. With multiple patents, industry honors and award-winning products, GlassCraft has consistently grown into one of the largest entry door manufacturers in the country,

From our 210,000 sq. ft. manufacturing facility in Houston, Texas, our teams of dedicated artisans, designers and master craftsmen have created a selection of the most beautiful doors, decorative glass, windows and entryways available. Our dedication to excellence is built into each product and continues with industry leading customer service and product warranties.

Why Buffalo Forge ThermaPremium

- Craftsmanship and Innovation - GlassCraft has more than 40 years of manufacturing excellence, producing high-quality exterior doors.
- Award-winning Innovation - The patented design used in Buffalo Forge line has been recognized by door and window experts for its unique door assembly and thermal break.
- Built for Security - Made of 14 and 18 gauge steel for a dent-proof door. Factory mounted flush bolts also provide secure locking of the passive door. Achieve maximum security while maintaining a clean look without surface mounted hardware.
- Premium in every detail - Carefully crafted and engineered for optimum quality, the Buffalo Forge line offers unique details including all composite threshold, built-in drainage system, ready-to-install & weather-proof entryway, reinforced door frame, and enhanced thermal break inside and out. All units are preassembled and tested before packing and shipping.
- Windstorm Rated - 80 DP Ratings.
- Made in USA and Ships in a few days.

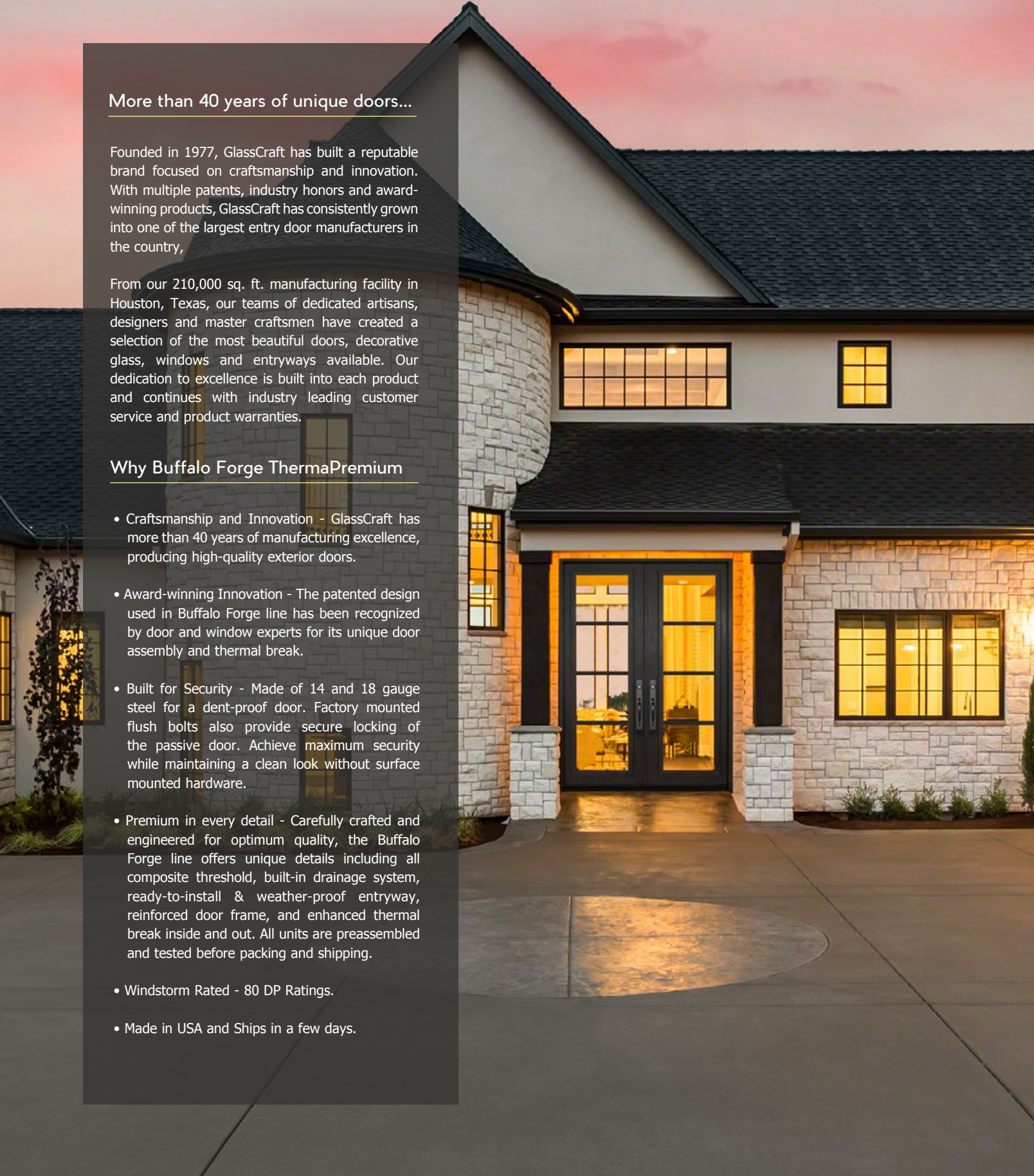

UNIQUE PATENTED PROCESS

Benefits of THERMAPREMIUM Doors with Thermal Break

GlassCraft's new BUFFALO FORGE THERMAPREMIUM entryways are in a class by themselves. There are many choices for high-end, hand-made steel and iron doors, but only Buffalo Forge ThermaPremium entryways are completely Thermally-Broken to provide the performance required and demanded when installed in your beautiful home.

What is a "Thermal Break"? All other steel and iron doors available utilize a construction design where the steel on the exterior front face of the door wraps around to the inside of the door. So severe heat (from the sun) or cold (ice and snow storm) wraps around too. Ten degrees outside your house? The INSIDE face of a door without our thermal barrier or "break" will ALSO be 10°. This is a big problem. The photo at right shows an actual installed steel door without our thermal break. Note the water condensation turning to frost and ice on the INSIDE of the door. Conversely, when the weather is 105° on the outside of your home, your steel door radiates 105° to the INSIDE of your house too. Very hot to the touch.

GlassCraft's patented THERMAPREMIUM doors eliminate this big problem and provide many additional benefits. The chart below details the features and benefits of our ThermaPremium doors in comparison to our ThermaPlus doors and to steel and iron doors offered by others. No comparison!

Why ThermaPremium is the Superior Choice

BENEFITS	Buffalo Forge ThermaPremium	Buffalo Forge ThermaPlus	Other Door Brands
Operable Glass Panels	√	no	?
Composite Edges on all 4 door edges	√	√	no
Patented door construction	√	√	no
Thermal Break on all parts	√	√	no
Reinforced Stiles on both door edges	√	√	no
Steel Reinforced composite door frames	√	no	no
Solid Stile and Rail construction	√	no	no
Accepts standard door hardware	√	√	no
Optional Glass Panel Hold-Open Arm available	√	no	no
Optional Multi-Point Locks available	√	√	no
Installation Flanges standard	√	no	no
1.75 inch thick doors standard	√	√	no
Unique cast ball-bearing hinges standard	√	no	no
All designs shipped in 3 weeks or less	√	√	no
Optional Brick Mold available	√	√	no
Windstorm Tested	√	√	?
Optional temporary construction doors available	√	√	?

GlassCraft Door Company reserves the right to change product designs and product specifications at any time for any reason and without notice. Standard lead-times may change without notice and should only be used as a guideline for placing orders.

For information on product warranty please visit our website at www.glasscraft.com

YOUR DOOR WITHOUT THERMAL BREAK

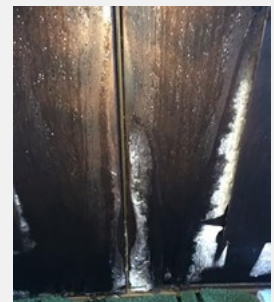

Steel door with NO thermal barrier can have condensation and frost on inside of door during winter.

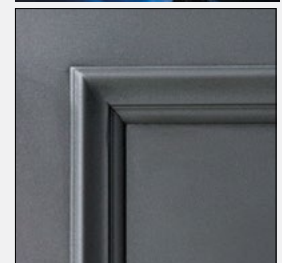
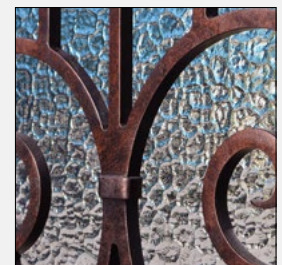

THREE DISTINCTIVE DESIGN SERIES

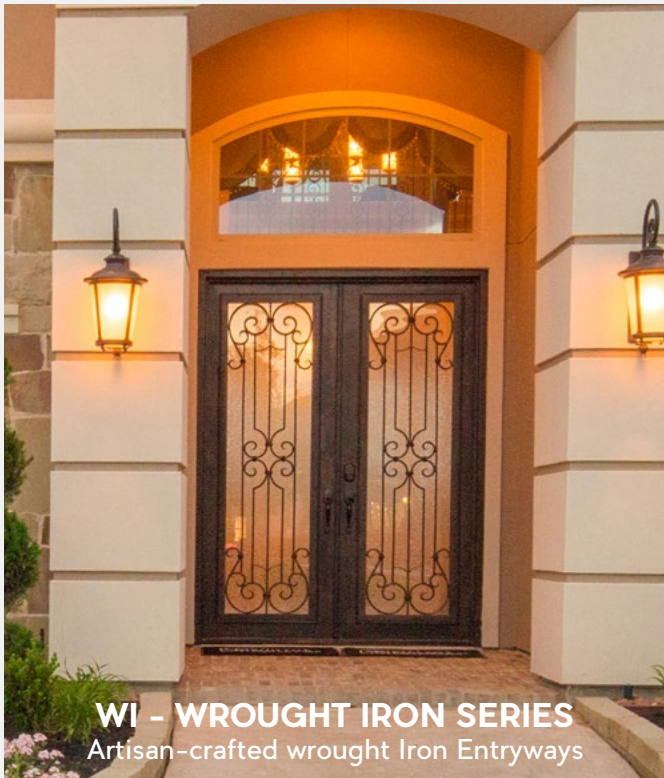

WI - WROUGHT IRON SERIES
Artisan-crafted wrought Iron Entryways



CD- CONTEMPORARY SERIES
Plasma-cut Steel Grid Entryways



PG - PRIVACY GLASS SERIES
Privacy Glass Entryways

Choose from many beautiful designs.

All three Series feature a unique "raised molding" appearance to give greater depth and detail to the exterior view of your door. Additional features include operable glass doors and optional screens. Premium in every detail, all doors in each series are made of 14 & 18 gauge durable steel with many decorative options available.

● **WI SERIES (Pages 18-39)**

Distinctive handcrafted wrought iron grilles with operable inner glass doors that are easy to clean and energy efficient. The wrought iron grille is not attached directly onto the door, but is welded onto a detailed border frame which extends beyond the front plane of the door. This construction method offers added strength and beauty-- a unique benefit only from GlassCraft!

● **CD SERIES (Pages 40-69)**

Features a unique and contemporary look of simplicity and style. All of these doors feature thick 14-gauge plasma-cut decorative steel grilles permanently attached to the exterior side of the door. Great for transitional, mid-century or minimalist home architecture.

● **PG SERIES (Pages 70-75)**

No external grid or grille with sleek and minimalist design. Choice of six glass textures and finishes. Perfect for patio or entryways.

GLASS OPTIONS for BUFFALO FORGE

THERMAPREMIUM with OPERABLE INNER GLASS DOORS

GlassCraft's Buffalo Forge ThermaPremium doors each include an operable inner glass door which operates separately from the main door and can be opened or closed for communication and ventilation. GlassCraft's exclusive designs include an integrated sloped inner-door sill and weep hole system built into the glass door panel and wrought iron design to allow rain water to drain to the exterior, away from the door and glass frame.

Open the glass panels to easily clean the glass behind the decorative wrought iron designs. The inner glass door uses compression weatherstripping to securely seal the operating glass frame, and includes a thermal-break design to significantly reduce the transfer of thermal energy from the outside to the inside.

An optional "hold-open arm" is available to hold the door open for ventilation. See photo at right.

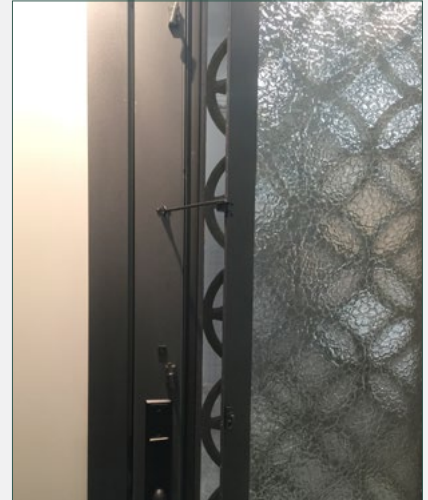

DOUBLE IG (INSULATED SAFETY GLASS)

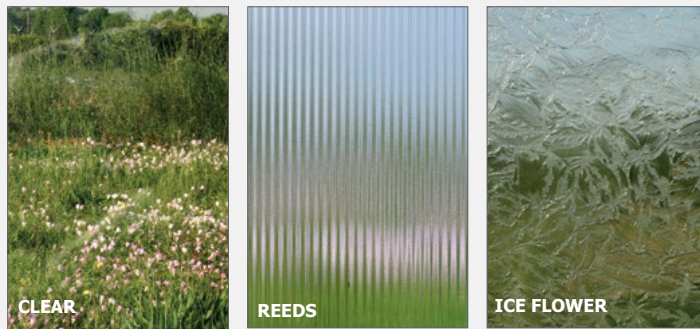

CLEAR
1 - PRIVACY RATING

REEDS
7 - PRIVACY RATING

ICE FLOWER
7 - PRIVACY RATING

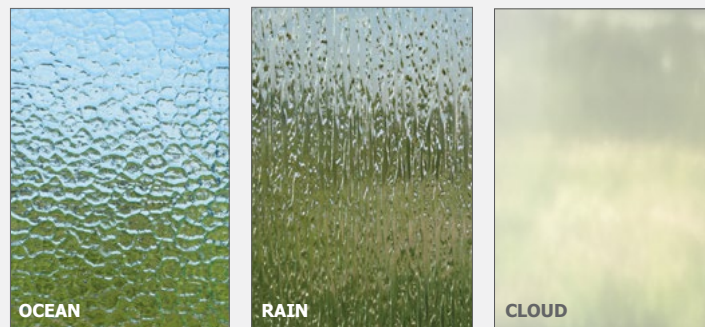

OCEAN
9 - PRIVACY RATING

RAIN
9 - PRIVACY RATING

CLOUD
9 - PRIVACY RATING

Choose from six different glass texture options to complement your Buffalo Forge ThermaPremium steel entry doors. All glass textures are produced with double IG (insulated glass) to provide safety, security and **energy efficiency**. All glass used in these panels are also **TEMPERED** for added safety.

The capacity to see through the glass panel varies depending upon the glass texture chosen. Ice Flower and Reeds glass options offer a moderate level of obscured view. Rain, Cloud, and Ocean give the highest level of privacy.

ESTATE FINISH OPTIONS for BUFFALO FORGE

ESTATE SATIN FINISH

Each Buffalo Forge unit is factory-finished with an automotive-grade paint process to provide the highest level of protection from environmental extremes for long-lasting use and enjoyment. These paint finishes will vary due to the nature of the hand-applied paint process. All finish colors listed include a low-20%-sheen top coat finish layer. Two Finish Levels are available....the Estate Finish and the Artisan Finish.

The six "Estate Satin" colors have a flat metal character. The four "Artisan Weathered Satin" colors on the opposite page utilize a hand-applied faux finish effect.

All six Estate Satin finish colors are the same price for each door. All Artisan finish colors are the same price for each door, with a price that is higher than the Estate colors due to significant additional hand-finishing required to achieve this effect. Pricing for both Estate and Artisan finishes are listed for each door in this catalog.

All 10 finish colors include a slightly textural tactile feel...not perfectly smooth.

Any finish shown on these two pages may be used for any of the Buffalo Forge entryways shown in this catalog.

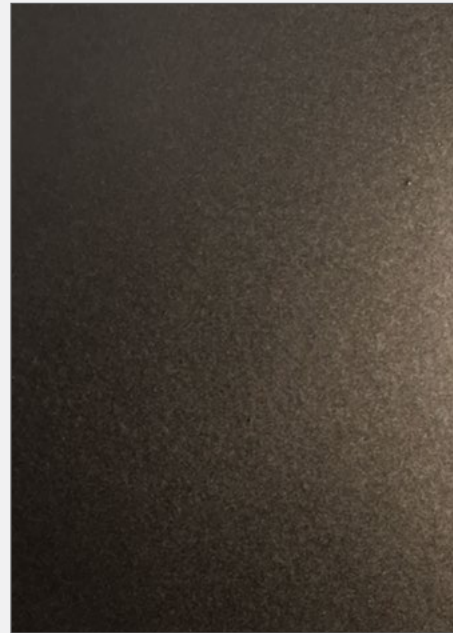

Detail photo showing slightly textured finish used on Estate finish. Artisan finish has more texture.

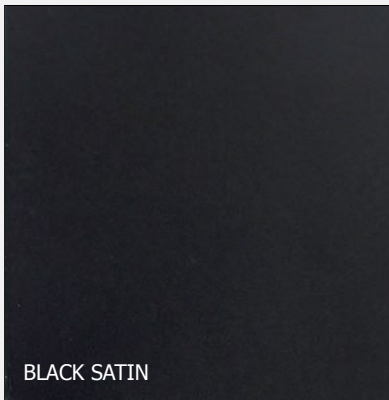

BLACK SATIN



DARK GREY SATIN



FRENCH GREY SATIN

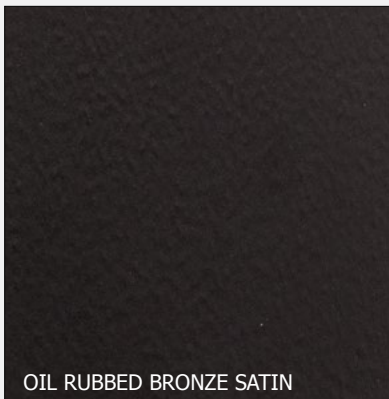

OIL RUBBED BRONZE SATIN



MEDIUM BRONZE SATIN



COPPER BRONZE SATIN

NOTE: The photos of the finish colors shown on these pages and throughout this catalog offer an indication of the final appearance. Due to the hand finish process, color of actual finished doors may vary.

ARTISAN FINISH OPTIONS for BUFFALO FORGE

ARTISAN WEATHERED SATIN FINISH

The Artisan - Series finishes below are all hand-applied, and the paint finishes will vary due to the nature of the hand-applied paint process. All Artisan finishes are the same price, and are priced higher than the Estate-Series finishes shown on the opposite page. Pricing for this Artisan finish is included below each door image in this catalog.

This Artisan finish has a slightly more textural feel and appearance than the smoother Estate finish shown on the opposite page. The Dark Grey and the Dark Bronze colors are more subtle than the Medium Grey and Medium Bronze, but all 4 weathered Artisan finish colors have color contrast and texture not seen in the Estate finish colors. A close-up photo of the Medium Bronze Weathered it at the bottom of the next page 8.

These finish colors may be applied to any of the doors in this catalog.



NOTE: The photos of the finish colors shown on these pages and throughout this catalog offer an indication of the final appearance. Due to the hand finish process, color of actual finished doors may vary.

BUFFALO FORGE THERMAPREMIUM - Standard features

Pre-hung Features

All Buffalo Forge THERMAPREMIUM doors are available as pre-hung units only...each entryway featuring several unique features to aid in the installation into the house. First, all units...both single and double doors...feature metal installation tabs on each side of the jamb legs to allow for a fast and adjustable connection. Next, the standard Pin Hinges allow for a quick mounting of the door into the door frames. In addition each hinge features 4 mounting holes for minimum 3-inch fasteners AND 2 additional bolts which hold the hinge in place during assembly. These hinge leaves offer the opportunity for fine-tuning and adjusting the swing of each door.



Use Standard Door Hardware including MultiPoint

All Buffalo Forge ThermaPremium doors are 1-3/4 inches thick. (Virtually all other premium steel doors are only 1-1/2 inches thick). This is important, as our full-thickness door allows for the use of almost any brand or type of door hardware, including single-point and multi-point hardware.

These doors have a built-in thermal-break consisting of a composite material on all 4 door edges. Because of this, a multi-point lock configuration may be mortised and / or mounted into the door.

As you decide what type of lock to mount on your door, remember that the best option for security is a multi-point lock. In addition, in extreme wind situations, a multi-point lock adds significant strength to the entire entryway.

As with other door hardware, multi-point locks come in a variety of styles and trim finishes. GlassCraft offers two different types of multi-point lock installation configurations. Please refer to page 13 for more information.



Patented Door Construction

These Buffalo Forge THERMAPREMIUM doors are unique...offering many features not available with any other door. The "Thermal-Break" feature is critical to the performance of your entryway, and is not available on other steel and iron doors.

GlassCraft has been awarded 6 US patents for the technology used in some or all of these Buffalo Forge doors.

Optional SCREEN

Add these optional screens to complement the operable glass panels of your ThermaPremium doors. These screens attach and detach easily and provide unobstructed view and uncompromised design and function. Great for improving ventilation and comfort inside the home. (The door in this photo includes the Artisan Medium Bronze Weathered finish).

BUFFALO FORGE THERMAPREMIUM - Options

Optional Hold-Open Arm

These Hold-Open Arms are attached to the inside door face immediately next to the operable inner glass door. The arm pivots, and latches into a ring attached to the inner glass door frame. When used, these will keep the inner glass door from slamming closed when another exterior of the house is opened or closed.

Hold Open Arm per door GSW170S \$45 - installed

Removable Screen Option

All entryways in this catalog include operable inner glass doors, and a unique removable screen option is available for all these doors. The screen features a black color screen and aluminum edge, and the screen attaches to the door with magnets. Easy installation and removal. The screen fits to the outside of the operable glass door, so you can open the inner glass door to allow for ventilation, and still keep the bugs out!

Rectangular full lite single door screen	BFSCR66	\$189
Rectangular 3/4 lite single door screen	BFSCR34	\$148
Rectangular full lite double door screen set	BFSCRD66	\$377
Rectangular 3/4 lite double door screen set	BFSCRD34	\$295
Arch top full lite double screen set	BFSCRAD66	\$548
Arch top 3/4 lite double screen set	BFSCRAD34	\$466

Brick Mold Available

Composite Brick Mold is available for all Buffalo Forge ThermaPremium units including for the arch top double doors. Composite material is black in color throughout, and is factory prefinished in the same color as is ordered for the door. Sold as a kit.

Single Doors	BMBFSGL	\$104
Double Doors	BMBFDBL	\$122
Arch Top Double Doors	BMBFATDL	\$336

Decorative Clavos Options

Use these decorative clavos for installation onto the lower panel of a door to give it a rustic or antique look. Clavos can be mounted on the interior, the exterior, or both sides. These clavos are hand-made and therefore vary slightly. Choose from the 8 clavos designs shown at right. The clavos will be finished in the same color as your door color selecton. Clavos are \$11 each installed onto the door.



Optional Hold-Open Hardware and Optional Screens

The hold-open arm secures the inner glass door open for ventilation, and the optional screens keep the insects out.

Refer to opposite page for a photo of the optional screens that attach magnetically, and then easily detaches when needed. The screens look seamless with the doors and do not obscure the view or functionality.



STANDARD PRE-HANG FRAME FEATURES for BUFFALO FORGE

Right Hand or Left Hand opening In-Swing or Out-Swing

All standard Buffalo Forge door designs are available with In-swing or Out-swing doors and can be ordered as left-handed or right-handed units. Please refer to the chart on page 17 to specify the handing when placing your order. All doors on the handing guide are viewed from the exterior of the home. Door units may also be ordered with ADA (Americans with Disabilities Act) accessible thresholds.

Jamb Size Options

All Buffalo Forge entryways shown in this catalog are pre-hung as assembled door units. We offer two jamb sizes, 4-5/8" wide or 6-5/8" wide to fit most construction needs.

The jamb includes pre-drilled mounting holes for easy installation of the door unit into all framing types. A full set of installation instructions and a how-to video are available to download from our website at www.glasscraft.com. If needed, you can use any standard brickmold and/or interior casing applications with the Buffalo Forge steel frame to fit seamlessly into your home's construction and trim options.

Steel Reinforced Composite Jamb Legs and Hinges

All entryways include a Thermally-Broken Door Frame which includes the jamb legs and header. These jamb legs include a steel reinforcement plate that is attached to the back side of each leg. In addition, a second steel plate is mounted to the back side of the steel hinges for further reinforcement.

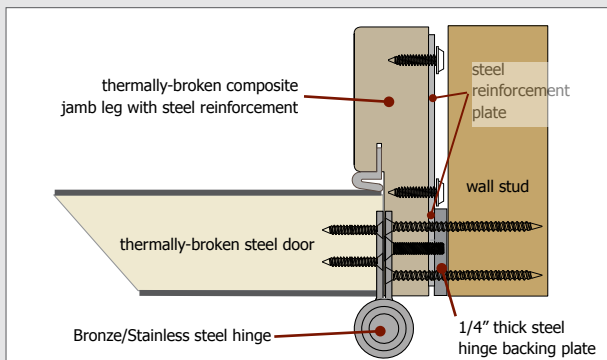

Standard Steel Reinforced Jamb Legs
Section drawing of the thermally broken jamb legs



All Buffalo Forge Door Pre-Hung Entryway units include these standard features:

- Option of 4-5/8" or 6-5/8" Jamb sizes
- Steel reinforced Jamb legs
- Double Insulated Safety Glass
- Pre-finishing with 15 painted faux finish options
- Standard Double bore lock preparation
- Factory mounted flush bolts
- Stock door sizes: 8' tall, 36" or 42" wide
- Weatherstripping
- Installation Bolts
- 14 and/or 18 Gauge steel for dent-free strong door
- 1-3/4" thick door panels

Endura Z-Series Sill System as standard

Buffalo Forge entryways use "Endura" brand solid adjustable composite sills which provide many benefits over wood or hollow aluminum sills/thresholds. These composite sills help prevent problems like water penetration under the threshold, rotting, warping, and discoloration. The Endura Z-Series Sill System provides a walnut colored sill cap, a black sill, the adjustability feature, and a hard plastic protective construction cover. The "adjustable" feature allows the top of the sill to be adjusted with a screwdriver to match the correct height required for the bottom of the door. Other steel door brands utilize a one-piece hollow aluminum threshold. These may dent with use over time, and potentially allow water penetration under the threshold. You may also select an optional ADA rated threshold.



Standard Endura Threshold

The Endura threshold is available in dark bronze finish and includes a removeable hard protective construction cover.

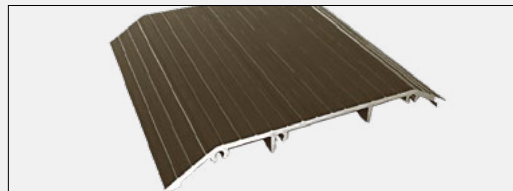

Optional ADA Threshold

The ADA threshold is approved for use with wheelchairs. Available in 5" x 1/2" or 7" x 1/2" sizes. No extra charge for this option.

Note: This ADA option does not guarantee that the door unit will meet all ADA requirements; please check with your local building inspectors to confirm ADA compliance.

Construction Doors Available

All standard Buffalo Forge entryways are available with an optional "construction" door or doors. These construction doors are solid, not hollow, and should last for the entire construction period of your home. They are meant to be discarded at the end of the construction process. These construction doors include steel pin-hinges to fit onto the Buffalo Forge hinge system mounted on the jamb leg.

Unique Bronze & Stainless Steel Hinges

All Buffalo Forge ThermoPremium entryways use multi-piece cast bronze and steel hinges with stainless steel hinge pins and ball bearings. Two of these beautiful and large 9-3/8 inch long x 1 inch diameter cast hinges are used on each door slab to keep your entryway operating smoothly for years to come. These removable hinges feature 6 inch hinge leaves with 6 fastener holes in each. Each hinge is reinforced by a 1/4 inch thick steel reinforcing plate mounted behind the jamb leg.

Other metal doors use regular 4 inch long door hinges that are unattractive, unsuitable for such heavy doors, and may rust and cause problems soon after installation. Buffalo Forge hinges offer the strength, security, and durability that is required for an entryway of this size and hefty weight.



Heavy-duty Cast Bronze/Stainless Steel Hinges

Installation Mounting Flange included

All Buffalo Forge entryways include mounting flanges on the outside edge of the door frame. The number of these flanges varies with the size of the entryway. These L-Shaped metal flanges allow for easy attachment of the door frame to the wood or metal wall studs immediately around the entryway opening.

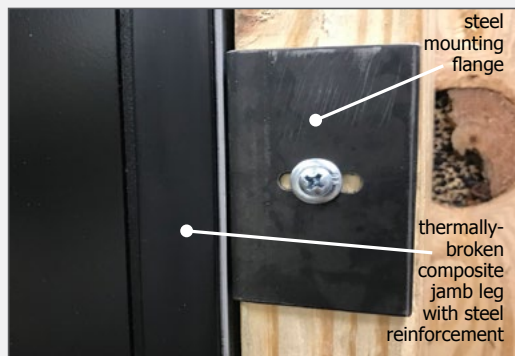

Standard Mounting Flange

All Buffalo Forge entryways include mounting flanges to assist in the installation process.

PRE-HUNG WINDSTORM RATED DOORS

Coastal Windstorm Approved

Protect your family and your home with GlassCraft's Coastal Windstorm Approved doors. Specific Buffalo Forge entryway configurations include this approval at no additional charge. See below for configurations. These entryways include a product certification label on the hinge-side jamb leg for viewing by the building inspector.

GlassCraft ThermaPremium entryways have been evaluated for compliance and are approved for installation in designated catastrophe areas along the Florida and Texas coastal areas when installed as required and as specified in the International Residential Code (IRC) and the International Building Code (IBC). These 8 foot tall entryways have been certified in a variety of entryway configurations, including single doors and double doors — all with inswing configurations.



80 DP Rating Available for Select Windstorm Tested Buffalo Forge ThermaPremium Doors.

Visit www.glasscraft.com for complete information on DP Ratings, approval numbers and availability for Windstorm tested product configurations.

Available Windstorm Configurations

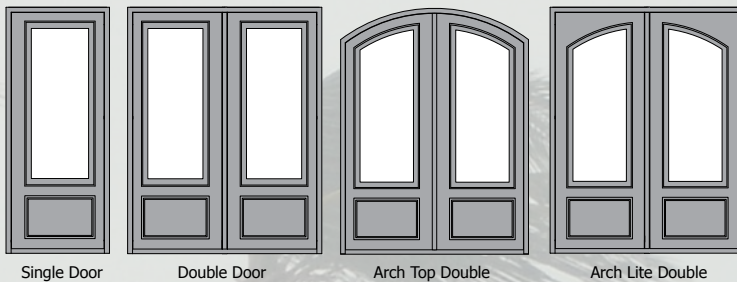

All pre-hung units shown include the use of steel-reinforced composite jamb materials (no wood parts), and a composite Endura-brand continuous sill.

Steel Reinforced Composite Components: Jamb legs, brick mold, quarter-round and t-astragals are available. Over 90% of the material used to produce our composite components are produced from recycled polymer and wood. The composite material accepts nails, staples, and screws within 1/2" of edge, and it has a low linear expansion from high or low temperature. Non-splintering, it will not twist and has excellent screw and nail retention. Cuts with any fine-tooth miter saw, and routes out beautifully with little or no chipping or ragged edges. Accepts paint and stain like real wood, and does not need priming.

Steel and Composite Frames: Included with all ThermaPremium Windstorm rated pre-hung units. The composite material used in the door frames and trim is of high-grade material with a smooth finish. The composite jamb legs are reinforced with 14 gauge steel along the length. These warp and rot-resistant frames are factory finished to match the finish on the door, and the pre-hung units are available factory finished to match a prefinished door. These Windstorm rated pre-hung door units are approved by the states of Florida and Texas. (No Impact Approval is available for these units).

Pre-hung "Inswing" and "Outswing" Units: We can pre-hang the four entryway configurations shown at left using our 3'0" or 3'6" wide x 8'0" tall ThermaPremium Steel doors. These 4 configurations are available as both "inswing" and "outswing" units, but Windstorm testing and approval is available ONLY for the inswing unit configurations. Pre-hung units include door sweep, weatherstripping, and adjustable threshold, plus 2 hinges on 8'0" doors, and astragals where applicable. Windstorm Certified pre-hung units must also include specific door hardware.

Prefinished Composite Pre-hang Entryways: The four entry configurations shown at above left are all available professionally prefinished. Please refer to our factory finish options on pages 6-7.

DROP FORGED SOLID BRASS HARDWARE

2 Different Door Hardware Options Available

All Buffalo Forge ThermaPremium doors are industry-standard 1-3/4 inches thick and can use standard and multipoint door lockset hardware with a 2-3/4" backset. Virtually ALL other suppliers of this type of door use doors that are 1-1/2" thick which makes it difficult to find door hardware that fits. You may use door hardware of your own, or select from one of our two types of door hardware shown on the next 2 pages. **IMPORTANT - Please note that hardware should NOT have a "lever" handle on the inside side of the door, as this lever will not allow the inner glass panel door to open.**

All doors will be pre-bored with a 2-3/4 inch backset for a handleset and/or dead bolt.

GlassCraft offers two different handle set door hardware options, and each type includes installation onto the door and the door jambs. Offered are a 2-point option and a multi-point option. The 2-point option is a standard handleset with dead bolt. All hardware is included.

The multi-point lock options provide additional security with 2 additional deadlocking tongues or bolts. This multi-point system is activated with the turning of the dead-bolt lock. These 3 locking points are engaged only when the dead bolt is locked and unlocked. Image at right shows the **A** top bolt and **E** bottom bolt, in addition to the standard **B** Center dead bolt and **C** Latch bolt.

Our multi-point lock set includes an anti-saw and kick-proof center dead bolt for maximum security and a 90-degree user-friendly locking operation, so you visually know the door is locked when the dead bolt knob is in the horizontal position. In addition, these multi-point assemblies are produced using heavy-gauge steel with a zinc dichromate finish per ATSM-8633 testing standard.

Multi-point lock systems use our standard GlassCraft flush bolts installed on the passive door of a pre-hung double door, which gives the homeowner the option to include dummy handle sets on the passive door with all multi-point or 2-point lock sets.

Precision-engineered components reduce the need for service calls, providing years of trouble-free service. These multi-point assemblies have been cycle-tested to exceed 300,000 locking cycles. Adjustable strike plates allow for field adjustment during and after installation. The design of these multi point systems allow for right hand or left hand installation with the same part.

GlassCraft provides installation of the multi-point lock mechanism into the door, and installation charges are included in the cost of these lock sets. Installation involves machining of the edge of the door slab, which is performed with CNC machines to ensure precision, in addition to machining the door jamb to perfectly match the multi-point hardware.

When ordering for double doors, only one multi-point lock set is required. You may choose to include a "dummy" handle set on the inactive door for appearance purposes.



Door shown above is an 8-0 tall ThermaPremium steel with Milano grille and multi-point lock set and Carmel handle.



Adjustable Strike Plates in Black or Antique Nickel are included in each handleset.

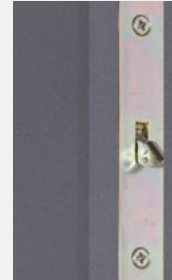

Closeup of Top Bolt

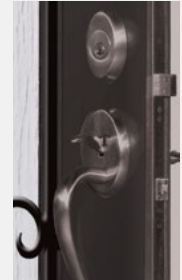

Multi-point center dead bolt and latch bolt.

OPTION ONE: SOLID BRASS 2-POINT HARDWARE

These large locksets look great on the big Buffalo Forge doors and are shown below as "two-point" traditional locksets. They may be used for right-hand or left-hand door swings. All necessary hardware is included. Installation into the steel door slab is included in the pricing of these two-point lock sets. Sizes shown below in inches. Matching "dummy" sets are available for double door installations for use on the inactive door. All Buffalo Forge ThermaPremium door latch sets use an egg-shaped knob on the inside side of the entryway. Nominal sizes shown below are in inches.

The door lockset hardware offered by GlassCraft is produced using the traditional drop-forged process using solid brass castings and made with heavy gauge construction, precision engineered mechanism, and superior corrosion protection. All use a standard 5 pin SC1 Keyway. Wide bow keys are provided. The "Dummy" sets can be used on inactive double door installations to match the locksets on the active door.

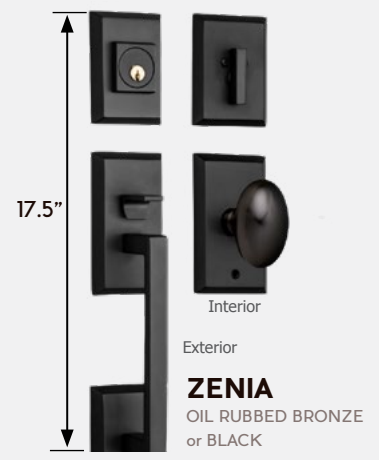
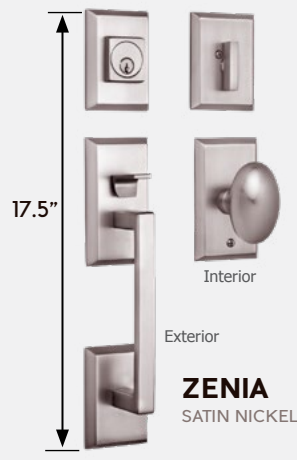
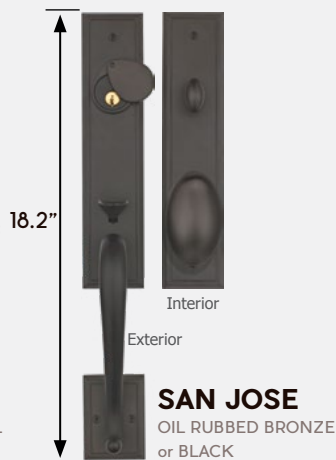
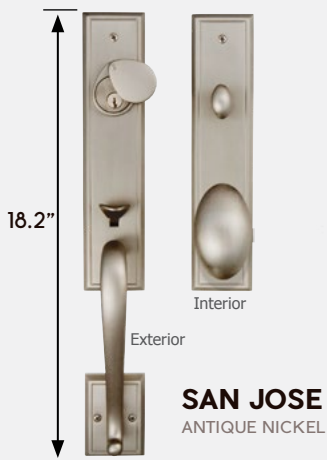

Trim Plate (top): 11.125" x 2.5"
Trim Plate (bottom): 3.5" x 2.5"
Total height: 18.2"

I47020CAN1PTBF Two-point \$1,219
I47020CANBF Dummy \$ 890

Trim Plate (top): 11.125" x 2.5"
Trim Plate (bottom): 3.5" x 2.5"
Total height: 18.2"

I47020CORB1PTBF Two-point \$1,060
I47020CORBBF Dummy \$ 750

Trim Plate (deadbolt): 3.94" x 2.75"
Trim Plate (top): 5" x 2.75"
Trim Plate (bottom): 3.94" x 2.75"
Total nominal height: 17.5"

IH310BN1PTBF Two-point \$1,099
IH310BNBF Dummy \$ 770

Trim Plate (deadbolt): 3.94" x 2.75"
Trim Plate (top): 5" x 2.75"
Trim Plate (bottom): 3.94" x 2.75"
Total nominal height: 17.5"

IH310ORB1PTBF Two-point \$1,099
IH310ORBBF Dummy \$ 770

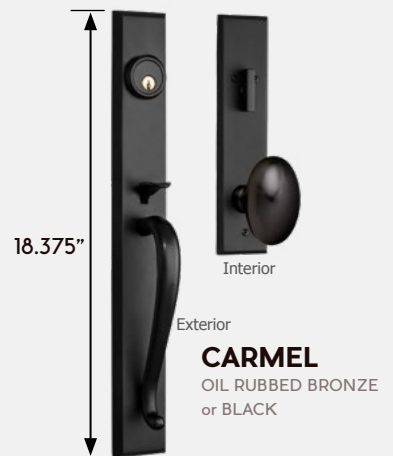

Trim Plate: 18.375" x 2.5"

IH700BN1PTBF Two-point \$1,174
IH700MPBNBF Dummy \$ 845

Trim Plate: 18.375" x 2.5"

IH700ORB1PTBF Two-point \$1,174
IH700MPORBBF Dummy \$ 845

Trim Plate: 18.375" x 2.5"

IH790BN1PTBF Two-point \$1,174
IH790BNBF Dummy \$ 845

Trim Plate: 18.375" x 2.5"

IH790ORB1PTBF Two-point \$1,174
IH790ORBBF Dummy \$ 845

OPTION TWO: SOLID BRASS MULTI-POINT HARDWARE

The locksets shown below feature multi-point locksets and may be used for right-hand or left-hand door swings. All necessary hardware is included. Installation into the door slab is included in the pricing of these multi-point lock sets. All use a standard 5 pin SC1 Keyway. Wide bow keys are provided. The "Dummy" sets can be used on inactive double door installations to match the locksets on the active door. Nominal sizes shown below in inches.

These drop-forged cast brass handlesets are matched with precision multi-point latching door systems to raise the bar for improved security and weather-resistance performance. This hardware features 4 latches – three are operated by the interior dead-bolt and the 4th is operated by the thumb latch. This system divides any forced-entry pressure or wind-load across the full length of the door instead of only in the middle. Strike plates are included for all latches points.

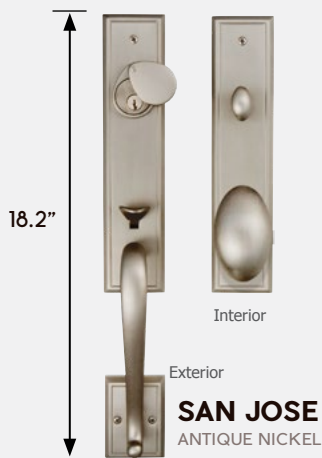

Trim Plate (top): 11.125" x 2.5"
Trim Plate (bottom): 3.5" x 2.5"
Total height: 18.2"

I47020CAN3PT80BF Four-point \$1,160
I47020CANBF Dummy \$ 890

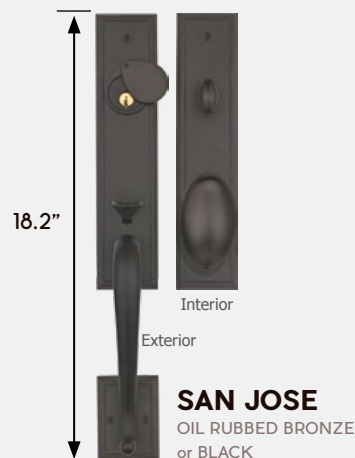

Trim Plate (top): 11.125" x 2.5"
Trim Plate (bottom): 3.5" x 2.5"
Total height: 18.2"

I47020CORB3PT80BF Four-point \$1,315
I47020CORBBF Dummy \$ 750

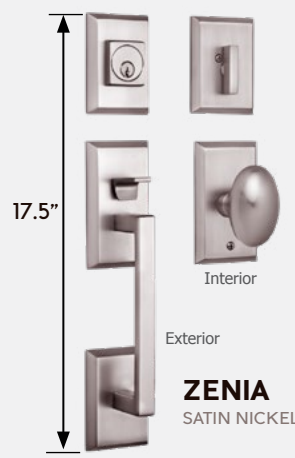

Trim Plate (deadbolt): 3.94" x 2.75"
Trim Plate (top): 5" x 2.75"
Trim Plate (bottom): 3.94" x 2.75"
Total nominal height: 17.5"

IH310BN3PT80BF Four-point \$1,190
IH310BNBF Dummy \$ 770

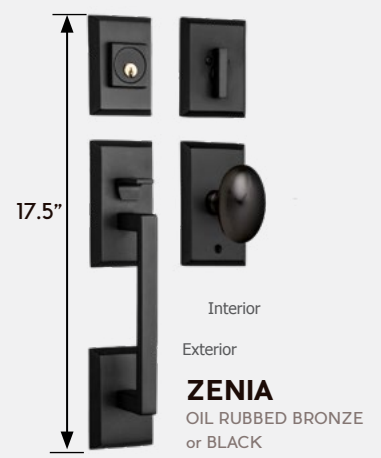

Trim Plate (deadbolt): 3.94" x 2.75"
Trim Plate (top): 5" x 2.75"
Trim Plate (bottom): 3.94" x 2.75"
Total nominal height: 17.5"

IH310ORB3PT80BF Four-point \$1,190
IH310ORBBF Dummy \$ 770



Trim Plate: 18.375" x 2.5"

IH700MPBN3PT80BF Four-point \$1,265
IH700MPBNBF Dummy \$ 845



Trim Plate: 18.375" x 2.5"

IH700MPORB3PT80BF Four-point \$1,265
IH700MPORBBF Dummy \$ 845



Trim Plate: 18.375" x 2.5"

IH790BN3PT80BF Four-point \$1,265
IH790BNBF Dummy \$ 845

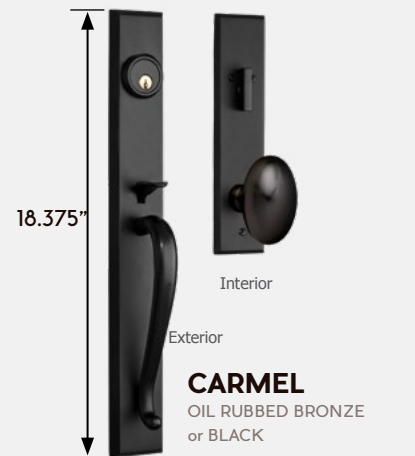

Trim Plate: 18.375" x 2.5"

IH790ORB3PT80BF Four-point \$1,265
IH790ORBBF Dummy \$ 845

BUFFALO FORGE UNIT DIMENSIONS

Listed below are the assembled pre-hung unit dimensions for the available Buffalo Forge ThermoPremium units. Please allow for a plus-or-minus 1/2 inch tolerance in these dimensions, and in the rough opening dimensions.

SINGLE DOOR UNIT DIMENSIONS

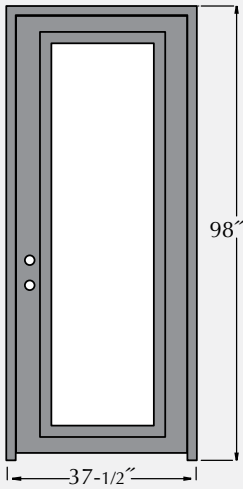

Single 36" Door

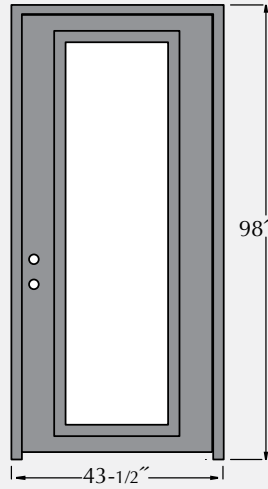

Single 42" Door

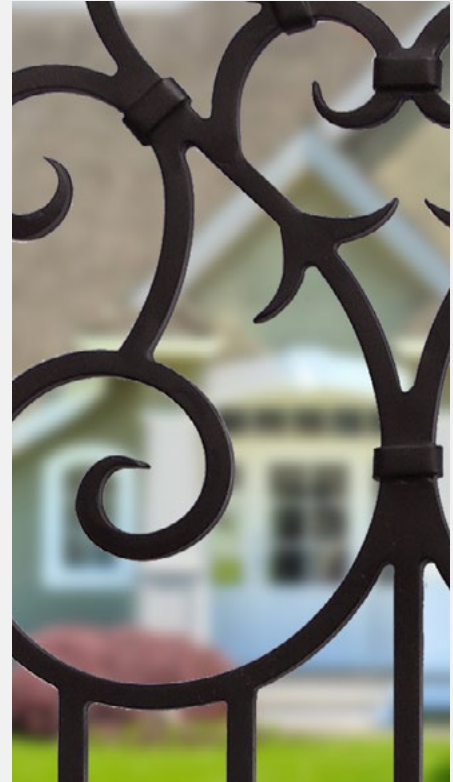

DOUBLE DOOR UNIT DIMENSIONS

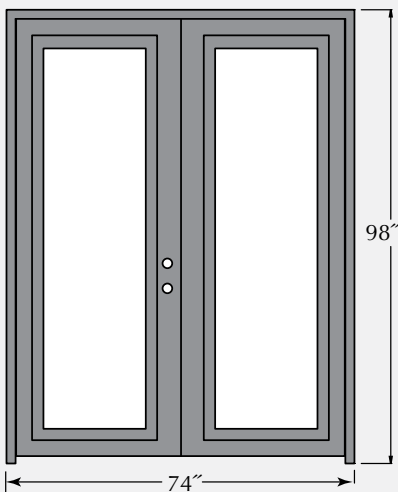

Double 36" Doors

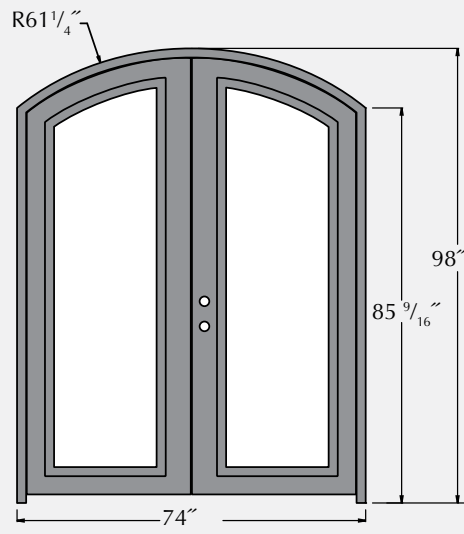

Double 36" Arch Top

Dimensions shown for 1.5" composite/steel framing system
To calculate the Rough Opening, add 3/4" to the width and 1/2" to the height of the unit dimensions.

BUFFALO FORGE DOOR HANDING GUIDE

All Buffalo Forge ThermaPremium units are available as "in swing" units or as "outswing" units. Please specify the door handing and in swing or out swing at time of ordering.

IN-SWING CONFIGURATIONS

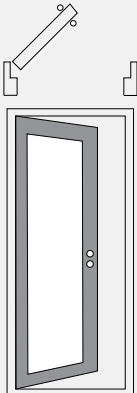

Left Hand In-swing

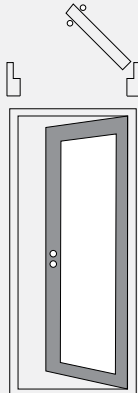

Right Hand In-swing

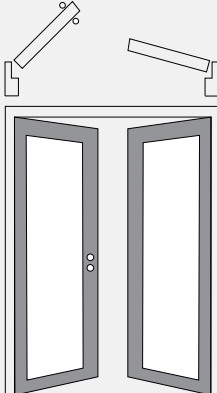

Left Hand In-swing

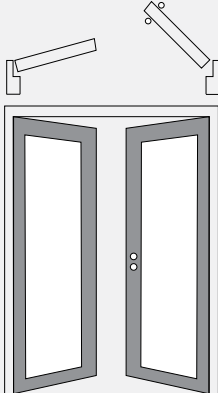

Right Hand In-swing

OUT-SWING CONFIGURATIONS

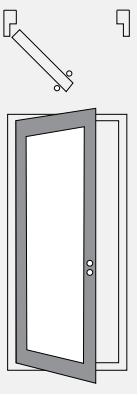

Left Hand Out-swing

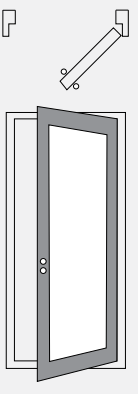

Right Hand Out-swing

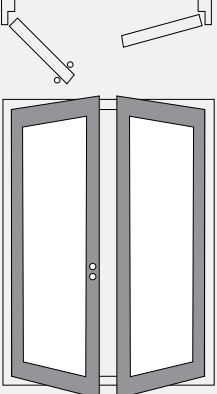

Left Hand Out-swing

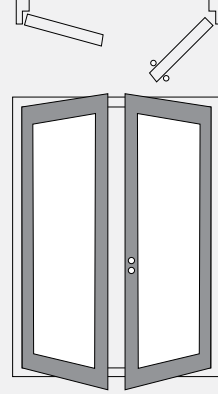

Right Hand Out-swing

All doors shown above are viewed from exterior.





Wrought Iron WI-Series Door

GlassCraft's Wrought Iron Series features stunning hand-forged grille designs and distinctive benefits not found in other doors, including its unique "raised moulding" detail that adds architectural depth, the unique "weep hole" design ensuring that rain water flows out and away from the door, and an operable tempered safety glass with air-tight and leak-proof design, plus a Polyurethane foam fill for energy efficiency. WI-Series offers beauty, strength and durability in every detail.

Photo: Marbella full Lite double door with Ocean glass and Carmel handleset.

WI-SERIES WROUGHT IRON DOORS

8'0" BUFFALO FORGE THERMAPREMIUM STEEL ENTRY DOORS

WI-SERIES 8'0" TALL BUFFALO FORGE STEEL DOORS



WI-Series Grille Designs

Six stunning wrought iron grille designs, carefully crafted by artisans: Barcelona, Bellagio, Milano, Tivoli, Valencia, and Marbella.

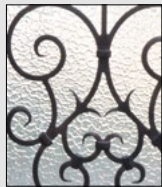

Marbella

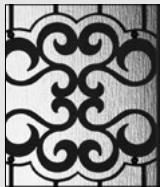

Tivoli



Valencia



Milano



Bellagio



Barcelona

WINDSTORM RATED and APPROVED



All WI-Series entryway designs have been certified by an independent laboratory to be windstorm approved. Please refer to our website for specific DP Ratings or design pressure certifications for each Buffalo Forge entry door configuration.

Unique features of GlassCraft's WI-Series

- Thermally-Broken patented design on the door, the jamb legs, and the door glass panel ensures thermal efficiency and comfort.
- Raised-moulding around the door and glass panels for enhanced architectural definition and depth.
- Factory mounted flush bolts for maximum security and clean look. No need for surface mounted hardware.
- Each unit is pre-assembled and installed into a test wall to ensure hassle-free onsite installation.
- Unique cast heavy-duty hinges with stainless steel pins for long-lasting use (see page 11).
- Six different glass textures are available (page 5).
- Premium two-point and multi-point handlesets options (see page 14-15), or use your own door hardware.
- Beautiful Estate and Artisan finish options (see page 7).
- Adjustable Endura solid composite thresholds to ensure a weatherproof seal. Other brands use hollow sills that don't adjust and can dent.
- Double Insulated glass panels for thermal efficiency.



Shown: Marbella Arch Top 3/4 Lite Double door with Ice Flower glass and Weathered Medium Bronze Artisan finish. San Jose multipoint handleset. Brick mold option.

3/4 Lite Arch Top Double WI-Series Entry Doors · 8'0" Tall



Barcelona®

Shown above with French Grey Satin finish, Rain glass texture, and optional clavos.



Marbella®

Shown above with Oil Rubbed Bronze Satin finish and Ice Flower glass texture.

WI-Series 3/4 Lite Arch Top Double Door					
Jamb width	Active Door Handing	Doors width	Item Number	List Price Estate	List Price Artisan
4-5/8"	Right Hand	36"	BF1834ATDBA4R	\$9,700	\$10,900
	Left Hand	36"	BF1834ATDBA4L	\$9,700	\$10,900
6-5/8"	Right Hand	36"	BF1834ATDBA6R	\$9,985	\$11,185
	Left hand	36"	BF1834ATDBA6L	\$9,985	\$11,185

Available Options:

- 2 jamb widths: 4-9/16" and 6-9/16" nominal
- 1 door width: 36"
- Inswing or Outswing
- 10 Factory Pre-finished Options. Add "A" after stock number for Artisan finish
- 6 Glass Textures. See page 5. All glass textures same price
- Optional clavos for lower panel: 20 clavos add \$220
- Optional Brick Mold trim to exterior side: add \$336
- Optional ADA Threshold: add \$90
- Optional construction doors and hinges: Hollow \$750 Solid \$1,250 (set of 2)
- Optional Screens (set of 2): \$466
- Optional Hold Open arm (set of 2) \$90

WI-Series 3/4 Lite Arch Top Double Door					
Jamb width	Active Door Handing	Doors width	Item Number	List Price Estate	List Price Artisan
4-5/8"	Right Hand	36"	BF1834ATDMB4R	\$9,700	\$10,900
	Left Hand	36"	BF1834ATDMB4L	\$9,700	\$10,900
6-5/8"	Right Hand	36"	BF1834ATDMB6R	\$9,985	\$11,185
	Left hand	36"	BF1834ATDMB6L	\$9,985	\$11,185

Available Options:

- 2 jamb widths: 4-9/16" and 6-9/16" nominal
- 1 door width: 36"
- Inswing or Outswing
- 10 Factory Pre-finished Options. Add "A" after stock number for Artisan finish
- 6 Glass Textures. See page 5. All glass textures same price
- Optional clavos for lower panel: 20 clavos add \$220
- Optional Brick Mold trim to exterior side: add \$336
- Optional ADA Threshold: add \$90
- Optional construction doors and hinges: Hollow \$750 Solid \$1,250 (set of 2)
- Optional Screens (set of 2): \$466
- Optional Hold Open arm (set of 2) \$90



3/4 Lite Arch Top Double WI-Series Entry Doors · 8'0" Tall



Tivoli

Shown above with Black Satin finish and Ocean glass texture.



Valencia

Shown above with French Grey Satin finish and Reeds glass texture.

WI-Series 3/4 Lite Arch Top Double Door					
Jamb width	Active Door Handing	Doors width	Item Number	List Price Estate	List Price Artisan
4-5/8"	Right Hand	36"	BF1834ATDTV4R	\$9,700	\$10,900
	Left Hand	36"	BF1834ATDTV4L	\$9,700	\$10,900
6-5/8"	Right Hand	36"	BF1834ATDTV6R	\$9,985	\$11,185
	Left hand	36"	BF1834ATDTV6L	\$9,985	\$11,185

Available Options:

- 2 jamb widths: 4-9/16" and 6-9/16" nominal
- 1 door width: 36"
- Inswing or Outswing
- 10 Factory Pre-finished Options. Add "A" after stock number for Artisan finish
- 6 Glass Textures. See page 5. All glass textures same price
- Optional clavos for lower panel: 20 clavos add \$220
- Optional Brick Mold trim to exterior side: add \$336
- Optional ADA Threshold: add \$90
- Optional construction doors and hinges: Hollow \$750 Solid \$1,250 (set of 2)
- Optional Screens (set of 2): \$466
- Optional Hold Open arm (set of 2) \$90



WI-Series 3/4 Lite Arch Top Double Door					
Jamb width	Active Door Handing	Doors width	Item Number	List Price Estate	List Price Artisan
4-5/8"	Right Hand	36"	BF1834ATDV4R	\$9,700	\$10,900
	Left Hand	36"	BF1834ATDV4L	\$9,700	\$10,900
6-5/8"	Right Hand	36"	BF1834ATDV6R	\$9,985	\$11,185
	Left hand	36"	BF1834ATDV6L	\$9,985	\$11,185

Available Options:

- 2 jamb widths: 4-9/16" and 6-9/16" nominal
- 1 door width: 36"
- Inswing or Outswing
- 10 Factory Pre-finished Options. Add "A" after stock number for Artisan finish
- 6 Glass Textures. See page 5. All glass textures same price
- Optional clavos for lower panel: 20 clavos add \$220
- Optional Brick Mold trim to exterior side: add \$336
- Optional ADA Threshold: add \$90
- Optional construction doors and hinges: Hollow \$750 Solid \$1,250 (set of 2)
- Optional Screens (set of 2): \$466
- Optional Hold Open arm (set of 2) \$90



Full Lite Arch Top Double WI-Series Entry Doors · 8'0" Tall



Barcelona®

Shown above with Black Satin finish and Ocean glass texture.



Bellagio

Shown above with Oil Rubbed Bronze Satin finish and Cloud glass texture.

WI-Series Full Lite Arch Top Double Door					
Jamb width	Active Door Handing	Doors width	Item Number	List Price Estate	List Price Artisan
4-5/8"	Right Hand	36"	BFI8ATDBA4R	\$9,500	\$10,700
	Left Hand	36"	BFI8ATDBA4L	\$9,500	\$10,700
6-5/8"	Right Hand	36"	BFI8ATDBA6R	\$9,785	\$10,985
	Left hand	36"	BFI8ATDBA6L	\$9,785	\$10,985

WI-Series Full Lite Arch Top Double Door					
Jamb width	Active Door Handing	Doors width	Item Number	List Price Estate	List Price Artisan
4-5/8"	Right Hand	36"	BFI8ATDB4R	\$9,500	\$10,700
	Left Hand	36"	BFI8ATDB4L	\$9,500	\$10,700
6-5/8"	Right Hand	36"	BFI8ATDB6R	\$9,785	\$10,985
	Left hand	36"	BFI8ATDB6L	\$9,785	\$10,985

Available Options:

2 jamb widths: 4-9/16" and 6-9/16" nominal
 1 door width: 36"
 Inswing or Outswing
 10 Factory Pre-finished Options. Add "A" after stock number for Artisan finish
 6 Glass Textures. See page 5. All glass textures same price
 Optional Brick Mold trim to exterior side: add \$336
 Optional ADA Threshold: add \$90
 Optional construction doors and hinges: Hollow \$750 Solid \$1,250 (set of 2)
 Optional Screens (set of 2): \$548
 Optional Hold Open arm (set of 2) \$90

Available Options:

2 jamb widths: 4-9/16" and 6-9/16" nominal
 1 door width: 36"
 Inswing or Outswing
 10 Factory Pre-finished Options. Add "A" after stock number for Artisan finish
 6 Glass Textures. See page 5. All glass textures same price
 Optional Brick Mold trim to exterior side: add \$336
 Optional ADA Threshold: add \$90
 Optional construction doors and hinges: Hollow \$750 Solid \$1,250 (set of 2)
 Optional Screens (set of 2): \$548
 Optional Hold Open arm (set of 2) \$90



Full Lite Arch Top Double WI-Series Entry Doors · 8'0" Tall



Tivoli

Shown above with Black Satin finish and Ice Flower glass.



Valencia

Shown above with Oil Rubbed Bronze Satin finish and Rain glass texture.

WI-Series Full Lite Arch Top Double Door					
Jamb width	Active Door Handing	Doors width	Item Number	List Price Estate	List Price Artisan
4-5/8"	Right Hand	36"	BF18ATDTV4R	\$9,500	\$10,700
	Left Hand	36"	BF18ATDTV4L	\$9,500	\$10,700
6-5/8"	Right Hand	36"	BF18ATDTV6R	\$9,785	\$10,985
	Left hand	36"	BF18ATDTV6L	\$9,785	\$10,985

WI-Series Full Lite Arch Top Double Door					
Jamb width	Active Door Handing	Doors width	Item Number	List Price Estate	List Price Artisan
4-5/8"	Right Hand	36"	BF18ATDV4R	\$9,500	\$10,700
	Left Hand	36"	BF18ATDV4L	\$9,500	\$10,700
6-5/8"	Right Hand	36"	BF18ATDV6R	\$9,785	\$10,985
	Left hand	36"	BF18ATDV6L	\$9,785	\$10,985

Available Options:

- 2 jamb widths: 4-9/16" and 6-9/16" nominal
- 1 door width: 36"
- Inswing or Outswing
- 10 Factory Pre-finished Options. Add "A" after stock number for Artisan finish
- 6 Glass Textures. See page 5. All glass textures same price
- Optional Brick Mold trim to exterior side: add \$336
- Optional ADA Threshold: add \$90
- Optional construction doors and hinges: Hollow \$750 Solid \$1,250 (set of 2)
- Optional Screens (set of 2): \$548
- Optional Hold Open arm (set of 2) \$90

Available Options:

- 2 jamb widths: 4-9/16" and 6-9/16" nominal
- 1 door width: 36"
- Inswing or Outswing
- 10 Factory Pre-finished Options. Add "A" after stock number for Artisan finish
- 6 Glass Textures. See page 5. All glass textures same price
- Optional Brick Mold trim to exterior side: add \$336
- Optional ADA Threshold: add \$90
- Optional construction doors and hinges: Hollow \$750 Solid \$1,250 (set of 2)
- Optional Screens (set of 2): \$548
- Optional Hold Open arm (set of 2) \$90



Full Lite Arch Top Double WI-Series Entry Doors · 8'0" Tall



Marbella®

Shown above with French Grey Satin finish and Reeds glass texture.



Milano®

Shown above with Black Satin finish and Ocean glass texture.

WI-Series Full Lite Arch Top Double Door					
Jamb width	Active Door Handing	Doors width	Item Number	List Price Estate	List Price Artisan
4-5/8"	Right Hand	36"	BF18ATDMB4R	\$9,500	\$10,700
	Left Hand	36"	BF18ATDMB4L	\$9,500	\$10,700
6-5/8"	Right Hand	36"	BF18ATDMB6R	\$9,785	\$10,985
	Left hand	36"	BF18ATDMB6L	\$9,785	\$10,985

Available Options:

2 jamb widths: 4-9/16" and 6-9/16" nominal
 1 door width: 36"
 Inswing or Outswing
 10 Factory Pre-finished Options. Add "A" after stock number for Artisan finish
 6 Glass Textures. See page 5. All glass textures same price
 Optional Brick Mold trim to exterior side: add \$336
 Optional ADA Threshold: add \$90
 Optional construction doors and hinges: Hollow \$750 Solid \$1,250 (set of 2)
 Optional Screens (set of 2): \$548
 Optional Hold Open arm (set of 2) \$90

WI-Series Full Lite Arch Top Double Door					
Jamb width	Active Door Handing	Doors width	Item Number	List Price Estate	List Price Artisan
4-5/8"	Right Hand	36"	BF18ATDM4R	\$9,500	\$10,700
	Left Hand	36"	BF18ATDM4L	\$9,500	\$10,700
6-5/8"	Right Hand	36"	BF18ATDM6R	\$9,785	\$10,985
	Left hand	36"	BF18ATDM6L	\$9,785	\$10,985

Available Options:

2 jamb widths: 4-9/16" and 6-9/16" nominal
 1 door width: 36"
 Inswing or Outswing
 10 Factory Pre-finished Options. Add "A" after stock number for Artisan finish
 6 Glass Textures. See page 5. All glass textures same price
 Optional Brick Mold trim to exterior side: add \$336
 Optional ADA Threshold: add \$90
 Optional construction doors and hinges: Hollow \$750 Solid \$1,250 (set of 2)
 Optional Screens (set of 2): \$548
 Optional Hold Open arm (set of 2) \$90



3/4 Arch Lite Double WI-Series Entry Doors · 8'0" Tall



Barcelona®

Shown above with Oil Rubbed Bronze Satin finish and Cloud glass texture.



Marbella®

Shown above with Black Satin finish and Ice Flower glass texture.

WI-Series 3/4 Lite Arch Lite Double Door

Jamb width	Active Door Handing	Doors width	Item Number	List Price Estate	List Price Artisan
4-5/8"	Right Hand	36"	BFI834STDBA4R	\$9,600	\$10,800
	Left Hand	36"	BFI834STDBA4L	\$9,600	\$10,800
6-5/8"	Right Hand	36"	BFI834STDBA6R	\$9,745	\$10,945
	Left hand	36"	BFI834STDBA6L	\$9,745	\$10,945

WI-Series 3/4 Lite Arch Lite Double Door

Jamb width	Active Door Handing	Doors width	Item Number	List Price Estate	List Price Artisan
4-5/8"	Right Hand	36"	BFI834STDMB4R	\$9,600	\$10,800
	Left Hand	36"	BFI834STDMB4L	\$9,600	\$10,800
6-5/8"	Right Hand	36"	BFI834STDMB6R	\$9,745	\$10,945
	Left hand	36"	BFI834STDMB6L	\$9,745	\$10,945

Available Options:

- 2 jamb widths: 4-9/16" and 6-9/16" nominal
- 1 door width: 36"
- Inswing or Outswing
- 10 Factory Pre-finished Options. Add "A" after stock number for Artisan finish
- 6 Glass Textures. See page 5. All glass textures same price
- Optional clavos for lower panel: 20 clavos add \$220
- Optional Brick Mold trim to exterior side: add \$122
- Optional ADA Threshold: add \$90
- Optional construction doors and hinges: Hollow \$750 Solid \$1,250 (set of 2)
- Optional Hold Open arm (set of 2) \$90
- Optional Screens (set of 2): \$466

Available Options:

- 2 jamb widths: 4-9/16" and 6-9/16" nominal
- 1 door width: 36"
- Inswing or Outswing
- 10 Factory Pre-finished Options. Add "A" after stock number for Artisan finish
- 6 Glass Textures. See page 5. All glass textures same price
- Optional clavos for lower panel: 20 clavos add \$220
- Optional Brick Mold trim to exterior side: add \$122
- Optional ADA Threshold: add \$90
- Optional construction doors and hinges: Hollow \$750 Solid \$1,250 (set of 2)
- Optional Hold Open arm (set of 2) \$90
- Optional Screens (set of 2): \$466

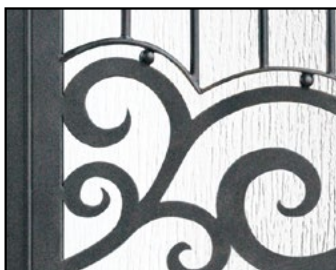

3/4 Arch Lite Double WI-Series Entry Doors · 8'0" Tall



Tivoli

Shown above with Black Satin finish and Reeds glass texture.



Valencia

Shown above with Black Satin finish and Ocean glass texture. Optional clavos shown.

WI-Series 3/4 Lite Arch Lite Double Door					
Jamb width	Active Door Handing	Doors width	Item Number	List Price Estate	List Price Artisan
4-5/8"	Right Hand	36"	BF1834STDTV4R	\$9,600	\$10,800
	Left Hand	36"	BF1834STDTV4L	\$9,600	\$10,800
6-5/8"	Right Hand	36"	BF1834STDTV6R	\$9,745	\$10,945
	Left hand	36"	BF1834STDTV6L	\$9,745	\$10,945

Available Options:

2 jamb widths: 4-9/16" and 6-9/16" nominal
 1 door width: 36"
 Inswing or Outswing
 10 Factory Pre-finished Options. Add "A" after stock number for Artisan finish
 6 Glass Textures. See page 5. All glass textures same price
 Optional clavos for lower panel: 20 clavos add \$220
 Optional Brick Mold trim to exterior side: add \$122
 Optional ADA Threshold: add \$90
 Optional construction doors and hinges: Hollow \$750 Solid \$1,250 (set of 2)
 Optional Hold Open arm (set of 2) \$90
 Optional Screens (set of 2): \$466

WI-Series 3/4 Lite Arch Lite Double Door					
Jamb width	Active Door Handing	Doors width	Item Number	List Price Estate	List Price Artisan
4-5/8"	Right Hand	36"	BF1834STDV4R	\$9,600	\$10,800
	Left Hand	36"	BF1834STDV4L	\$9,600	\$10,800
6-5/8"	Right Hand	36"	BF1834STDV6R	\$9,745	\$10,945
	Left hand	36"	BF1834STDV6L	\$9,745	\$10,945

Available Options:

2 jamb widths: 4-9/16" and 6-9/16" nominal
 1 door width: 36"
 Inswing or Outswing
 10 Factory Pre-finished Options. Add "A" after stock number for Artisan finish
 6 Glass Textures. See page 5. All glass textures same price
 Optional clavos for lower panel: 20 clavos add \$220
 Optional Brick Mold trim to exterior side: add \$122
 Optional ADA Threshold: add \$90
 Optional construction doors and hinges: Hollow \$750 Solid \$1,250 (set of 2)
 Optional Hold Open arm (set of 2) \$90
 Optional Screens (set of 2): \$466



Full Arch Lite Double WI-Series Entry Doors · 8'0" Tall



Barcelona®

Shown above with French Grey Satin finish and Clear glass texture.



Bellagio

Shown above with Black Satin finish and Rain glass texture.

WI-Series Full Lite Arch Lite Double Door					
Jamb width	Active Door Handing	Doors width	Item Number	List Price Estate	List Price Artisan
4-5/8"	Right Hand	36"	BF18STDBA4R	\$9,400	\$10,600
	Left Hand	36"	BF18STDBA4L	\$9,400	\$10,600
6-5/8"	Right Hand	36"	BF18STDBA6R	\$9,545	\$10,745
	Left hand	36"	BF18STDBA6L	\$9,545	\$10,745

Available Options:

- 2 jamb widths: 4-9/16" and 6-9/16" nominal
- 1 door width: 36"
- Inswing or Outswing
- 10 Factory Pre-finished Options. Add "A" after stock number for Artisan finish
- 6 Glass Textures. See page 5. All glass textures same price
- Optional Brick Mold trim to exterior side: add \$122
- Optional ADA Threshold: add \$90
- Optional construction doors and hinges: Hollow \$750 Solid \$1,250 (set of 2)
- Optional Hold Open arm (set of 2) \$90
- Optional Screens (set of 2): \$548

WI-Series Full Lite Arch Lite Double Door					
Jamb width	Active Door Handing	Doors width	Item Number	List Price Estate	List Price Artisan
4-5/8"	Right Hand	36"	BF18STDB4R	\$9,400	\$10,600
	Left Hand	36"	BF18STDB4L	\$9,400	\$10,600
6-5/8"	Right Hand	36"	BF18STDB6R	\$9,545	\$10,745
	Left hand	36"	BF18STDB6L	\$9,545	\$10,745

Available Options:

- 2 jamb widths: 4-9/16" and 6-9/16" nominal
- 1 door width: 36"
- Inswing or Outswing
- 10 Factory Pre-finished Options. Add "A" after stock number for Artisan finish
- 6 Glass Textures. See page 5. All glass textures same price
- Optional Brick Mold trim to exterior side: add \$122
- Optional ADA Threshold: add \$90
- Optional construction doors and hinges: Hollow \$750 Solid \$1,250 (set of 2)
- Optional Hold Open arm (set of 2) \$90
- Optional Screens (set of 2): \$548



Full Arch Lite Double WI-Series Entry Doors · 8'0" Tall



Marbella®

Shown above with Black Satin finish and Reeds glass texture.



Milano®

Shown above with Bronze ORB Satin finish and Cloud glass texture.

WI-Series Full Lite Arch Lite Double Door					
Jamb width	Active Door Handing	Doors width	Item Number	List Price Estate	List Price Artisan
4-5/8"	Right Hand	36"	BFI8STDMB4R	\$9,400	\$10,600
	Left Hand	36"	BFI8STDMB4L	\$9,400	\$10,600
6-5/8"	Right Hand	36"	BFI8STDMB6R	\$9,545	\$10,745
	Left hand	36"	BFI8STDMB6L	\$9,545	\$10,745

Available Options:

2 jamb widths: 4-9/16" and 6-9/16" nominal
 1 door width: 36"
 Inswing or Outswing
 10 Factory Pre-finished Options. Add "A" after stock number for Artisan finish
 6 Glass Textures. See page 5. All glass textures same price
 Optional Brick Mold trim to exterior side: add \$122
 Optional ADA Threshold: add \$90
 Optional construction doors and hinges: Hollow \$750 Solid \$1,250 (set of 2)
 Optional Strike Jamb reinforcement: \$150
 Optional Screens (set of 2): \$548
 Optional Hold Open arm (set of 2) \$90

WI-Series Full Lite Arch Lite Double Door					
Jamb width	Active Door Handing	Doors width	Item Number	List Price Estate	List Price Artisan
4-5/8"	Right Hand	36"	BFI8STDM4R	\$9,400	\$10,600
	Left Hand	36"	BFI8STDM4L	\$9,400	\$10,600
6-5/8"	Right Hand	36"	BFI8STDM6R	\$9,545	\$10,745
	Left hand	36"	BFI8STDM6L	\$9,545	\$10,745

Available Options:

2 jamb widths: 4-9/16" and 6-9/16" nominal
 1 door width: 36"
 Inswing or Outswing
 10 Factory Pre-finished Options. Add "A" after stock number for Artisan finish
 6 Glass Textures. See page 5. All glass textures same price
 Optional Brick Mold trim to exterior side: add \$122
 Optional ADA Threshold: add \$90
 Optional construction doors and hinges: Hollow \$750 Solid \$1,250 (set of 2)
 Optional Strike Jamb reinforcement: \$150
 Optional Screens (set of 2): \$548
 Optional Hold Open arm (set of 2) \$90



Full Arch Lite Double WI-Series Entry Doors · 8'0" Tall



Tivoli

Shown above with Black Satin finish and Clear glass.



Valencia

Shown above with Oil Rubbed Bronze Satin finish and Ocean glass texture.

WI-Series Full Lite Arch Lite Double Door					
Jamb width	Active Door Handing	Doors width	Item Number	List Price Estate	List Price Artisan
4-5/8"	Right Hand	36"	BF18STDTV4R	\$9,400	\$10,600
	Left Hand	36"	BF18STDTV4L	\$9,400	\$10,600
6-5/8"	Right Hand	36"	BF18STDTV6R	\$9,545	\$10,745
	Left hand	36"	BF18STDTV6L	\$9,545	\$10,745

WI-Series Full Lite Arch Lite Double Door					
Jamb width	Active Door Handing	Doors width	Item Number	List Price Estate	List Price Artisan
4-5/8"	Right Hand	36"	BF18STDV4R	\$9,400	\$10,600
	Left Hand	36"	BF18STDV4L	\$9,400	\$10,600
6-5/8"	Right Hand	36"	BF18STDV6R	\$9,545	\$10,745
	Left hand	36"	BF18STDV6L	\$9,545	\$10,745

Available Options:

2 jamb widths: 4-9/16" and 6-9/16" nominal
 1 door width: 36"
 Inswing or Outswing
 10 Factory Pre-finished Options. Add "A" after stock number for Artisan finish
 6 Glass Textures. See page 5. All glass textures same price
 Optional Brick Mold trim to exterior side: add \$122
 Optional ADA Threshold: add \$90
 Optional construction doors and hinges: Hollow \$750 Solid \$1,250 (set of 2)
 Optional Strike Jamb reinforcement: \$150
 Optional Screens (set of 2): \$548
 Optional Hold Open arm (set of 2) \$90

Available Options:

2 jamb widths: 4-9/16" and 6-9/16" nominal
 1 door width: 36"
 Inswing or Outswing
 10 Factory Pre-finished Options. Add "A" after stock number for Artisan finish
 6 Glass Textures. See page 5. All glass textures same price
 Optional Brick Mold trim to exterior side: add \$122
 Optional ADA Threshold: add \$90
 Optional construction doors and hinges: Hollow \$750 Solid \$1,250 (set of 2)
 Optional Strike Jamb reinforcement: \$150
 Optional Screens (set of 2): \$548
 Optional Hold Open arm (set of 2) \$90



Full Lite Double WI-Series Entry Doors · 8'0" Tall



Barcelona®

Shown above with French Grey Satin finish and Clear glass.



Bellagio

Shown above with Oil Rubbed Bronze Satin finish and Ocean glass texture.

WI-Series Full Lite Double Door					
Jamb width	Active Door Handing	Doors width	Item Number	List Price Estate	List Price Artisan
4-5/8"	Right Hand	36"	BF18FDBA4R	\$8,600	\$9,800
	Left Hand	36"	BF18FDBA4L	\$8,600	\$9,800
6-5/8"	Right Hand	36"	BF18FDBA6R	\$8,745	\$9,945
	Left hand	36"	BF18FDBA6L	\$8,745	\$9,945

Available Options:

2 jamb widths: 4-9/16" and 6-9/16" nominal
 1 door width: 36"
 Inswing or Outswing
 10 Factory Pre-finished Options. Add "A" after stock number for Artisan finish
 6 Glass Textures. See page 5. All glass textures same price
 Optional Brick Mold trim to exterior side: add \$122
 Optional ADA Threshold: add \$90
 Optional construction doors and hinges: Hollow \$750 Solid \$1,250 (set of 2)
 Optional Screens (set of 2): \$377
 Optional Hold Open Arms (set of 2): \$90

WI-Series Full Lite Double Door					
Jamb width	Active Door Handing	Doors width	Item Number	List Price Estate	List Price Artisan
4-5/8"	Right Hand	36"	BF18FDB4R	\$8,600	\$9,800
	Left Hand	36"	BF18FDB4L	\$8,600	\$9,800
6-5/8"	Right Hand	36"	BF18FDB6R	\$8,745	\$9,945
	Left hand	36"	BF18FDB6L	\$8,745	\$9,945

Available Options:

2 jamb widths: 4-9/16" and 6-9/16" nominal
 1 door width: 36"
 Inswing or Outswing
 10 Factory Pre-finished Options. Add "A" after stock number for Artisan finish
 6 Glass Textures. See page 5. All glass textures same price
 Optional Brick Mold trim to exterior side: add \$122
 Optional ADA Threshold: add \$90
 Optional construction doors and hinges: Hollow \$750 Solid \$1,250 (set of 2)
 Optional Screens (set of 2): \$377
 Optional Hold Open Arms (set of 2): \$90

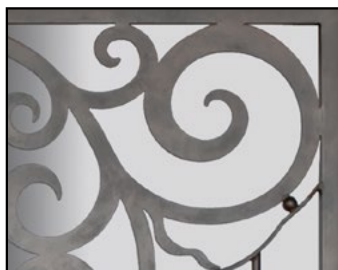

Full Lite Double WI-Series Entry Doors · 8'0" Tall



Marbella®

Shown above with Medium Bronze Satin finish and Rain glass texture.



Milano®

Shown above with French Grey Satin finish and Ice Flower glass texture.

WI-Series Full Lite Double Door					
Jamb width	Active Door Handing	Doors width	Item Number	List Price Estate	List Price Artisan
4-5/8"	Right Hand	36"	BF18FDMA4R	\$8,600	\$9,800
	Left Hand	36"	BF18FDMA4L	\$8,600	\$9,800
6-5/8"	Right Hand	36"	BF18FDMA6R	\$8,745	\$9,945
	Left hand	36"	BF18FDMA6L	\$8,745	\$9,945

WI-Series Full Lite Double Door					
Jamb width	Active Door Handing	Doors width	Item Number	List Price Estate	List Price Artisan
4-5/8"	Right Hand	36"	BF18FDM4R	\$8,600	\$9,800
	Left Hand	36"	BF18FDM4L	\$8,600	\$9,800
6-5/8"	Right Hand	36"	BF18FDM6R	\$8,745	\$9,945
	Left hand	36"	BF18FDM6L	\$8,745	\$9,945

Available Options:

- 2 jamb widths: 4-9/16" and 6-9/16" nominal
- 1 door width: 36"
- Inswing or Outswing
- 10 Factory Pre-finished Options. Add "A" after stock number for Artisan finish
- 6 Glass Textures. See page 5. All glass textures same price
- Optional Brick Mold trim to exterior side: add \$122
- Optional ADA Threshold: add \$90
- Optional construction doors and hinges: Hollow \$750 Solid \$1,250 (set of 2)
- Optional Screens (set of 2): \$377
- Optional Hold Open Arms (set of 2): \$90

Available Options:

- 2 jamb widths: 4-9/16" and 6-9/16" nominal
- 1 door width: 36"
- Inswing or Outswing
- 10 Factory Pre-finished Options. Add "A" after stock number for Artisan finish
- 6 Glass Textures. See page 5. All glass textures same price
- Optional Brick Mold trim to exterior side: add \$122
- Optional ADA Threshold: add \$90
- Optional construction doors and hinges: Hollow \$750 Solid \$1,250 (set of 2)
- Optional Screens (set of 2): \$377
- Optional Hold Open Arms (set of 2): \$90



Full Lite Double WI-Series Entry Doors · 8'0" Tall



Tivoli

Shown above with French Grey Satin finish and Rain glass texture.



Valencia

Shown above with French Grey Satin finish and Reeds glass texture.

WI-Series Full Lite Double Door					
Jamb width	Active Door Handing	Doors width	Item Number	List Price Estate	List Price Artisan
4-5/8"	Right Hand	36"	BF18FDTV4R	\$8,600	\$9,800
	Left Hand	36"	BF18FDTV4L	\$8,600	\$9,800
6-5/8"	Right Hand	36"	BF18FDTV6R	\$8,745	\$9,945
	Left hand	36"	BF18FDTV6L	\$8,745	\$9,945

Available Options:

- 2 jamb widths: 4-9/16" and 6-9/16" nominal
- 1 door width: 36"
- Inswing or Outswing
- 10 Factory Pre-finished Options. Add "A" after stock number for Artisan finish
- 6 Glass Textures. See page 5. All glass textures same price
- Optional Brick Mold trim to exterior side: add \$122
- Optional ADA Threshold: add \$90
- Optional construction doors and hinges: Hollow \$750 Solid \$1,250 (set of 2)
- Optional Screens (set of 2): \$377
- Optional Hold Open Arms (set of 2): \$90

WI-Series Full Lite Double Door					
Jamb width	Active Door Handing	Doors width	Item Number	List Price Estate	List Price Artisan
4-5/8"	Right Hand	36"	BF18FDV4R	\$8,600	\$9,800
	Left Hand	36"	BF18FDV4L	\$8,600	\$9,800
6-5/8"	Right Hand	36"	BF18FDV6R	\$8,745	\$9,945
	Left hand	36"	BF18FDV6L	\$8,745	\$9,945

Available Options:

- 2 jamb widths: 4-9/16" and 6-9/16" nominal
- 1 door width: 36"
- Inswing or Outswing
- 10 Factory Pre-finished Options. Add "A" after stock number for Artisan finish
- 6 Glass Textures. See page 5. All glass textures same price
- Optional Brick Mold trim to exterior side: add \$122
- Optional ADA Threshold: add \$90
- Optional construction doors and hinges: Hollow \$750 Solid \$1,250 (set of 2)
- Optional Screens (set of 2): \$377
- Optional Hold Open Arms (set of 2): \$90

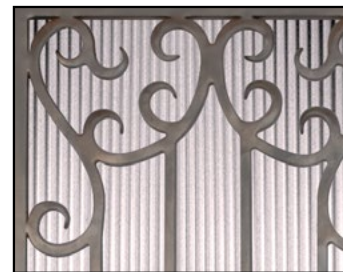

3/4 Lite Double WI-Series Entry Doors · 8'0" Tall



Barcelona®

Shown above with Oil Rubbed Bronze Satin finish and Reeds glass texture.



Marbella®

Shown above with French Grey Satin finish and Ocean glass texture. Optional clavos shown.

WI-Series 3/4 Lite Double Door					
Jamb width	Active Door Handing	Doors width	Item Number	List Price Estate	List Price Artisan
4-5/8"	Right Hand	36"	BF1834DBA4R	\$9,150	\$10,350
	Left Hand	36"	BF1834DBA4L	\$9,150	\$10,350
6-5/8"	Right Hand	36"	BF1834DBA6R	\$9,295	\$10,495
	Left hand	36"	BF1834DBA6L	\$9,295	\$10,495

WI-Series 3/4 Lite Double Door					
Jamb width	Active Door Handing	Doors width	Item Number	List Price Estate	List Price Artisan
4-5/8"	Right Hand	36"	BF1834DMA4R	\$9,150	\$10,350
	Left Hand	36"	BF1834DMA4L	\$9,150	\$10,350
6-5/8"	Right Hand	36"	BF1834DMA6R	\$9,295	\$10,495
	Left hand	36"	BF1834DMA6L	\$9,295	\$10,495

Available Options:

- 2 jamb widths: 4-9/16" and 6-9/16" nominal
- 1 door width: 36"
- Inswing or Outswing
- 10 Factory Pre-finished Options. Add "A" after stock number for Artisan finish
- 6 Glass Textures. See page 5. All glass textures same price
- Optional clavos for lower panel: 20 clavos add \$220
- Optional Brick Mold trim to exterior side: add \$122
- Optional ADA Threshold: add \$90
- Optional construction doors and hinges: Hollow \$750 Solid \$1,250 (set of 2)
- Optional Hold Open arm (set of 2) \$90
- Optional Screens (set of 2): \$295



Available Options:

- 2 jamb widths: 4-9/16" and 6-9/16" nominal
- 1 door width: 36"
- Inswing or Outswing
- 10 Factory Pre-finished Options. Add "A" after stock number for Artisan finish
- 6 Glass Textures. See page 5. All glass textures same price
- Optional clavos for lower panel: 20 clavos add \$220
- Optional Brick Mold trim to exterior side: add \$122
- Optional ADA Threshold: add \$90
- Optional construction doors and hinges: Hollow \$750 Solid \$1,250 (set of 2)
- Optional Hold Open arm (set of 2) \$90
- Optional Screens (set of 2): \$295



3/4 Lite Double WI-Series Entry Doors · 8'0" Tall



Tivoli

Shown above with Black Satin finish and Rain glass texture.



Valencia

Shown above with Black Satin finish and Ice Flower glass texture.

WI-Series 3/4 Lite Double Door					
Jamb width	Active Door Handing	Doors width	Item Number	List Price Estate	List Price Artisan
4-5/8"	Right Hand	36"	BF1834DTV4R	\$9,150	\$10,350
	Left Hand	36"	BF1834DTV4L	\$9,150	\$10,350
6-5/8"	Right Hand	36"	BF1834DTV6R	\$9,295	\$10,495
	Left hand	36"	BF1834DTV6L	\$9,295	\$10,495

Available Options:

- 2 jamb widths: 4-9/16" and 6-9/16" nominal
- 1 door width: 36"
- Inswing or Outswing
- 10 Factory Pre-finished Options. Add "A" after stock number for Artisan finish
- 6 Glass Textures. See page 5. All glass textures same price
- Optional clavos for lower panel: 20 clavos add \$220
- Optional Brick Mold trim to exterior side: add \$122
- Optional ADA Threshold: add \$90
- Optional construction doors and hinges: Hollow \$750 Solid \$1,250 (set of 2)
- Optional Hold Open arm (set of 2) \$90
- Optional Screens (set of 2): \$295

WI-Series 3/4 Lite Double Door					
Jamb width	Active Door Handing	Doors width	Item Number	List Price Estate	List Price Artisan
4-5/8"	Right Hand	36"	BF1834DV4R	\$9,150	\$10,350
	Left Hand	36"	BF1834DV4L	\$9,150	\$10,350
6-5/8"	Right Hand	36"	BF1834DV6R	\$9,295	\$10,495
	Left hand	36"	BF1834DV6L	\$9,295	\$10,495

Available Options:

- 2 jamb widths: 4-9/16" and 6-9/16" nominal
- 1 door width: 36"
- Inswing or Outswing
- 10 Factory Pre-finished Options. Add "A" after stock number for Artisan finish
- 6 Glass Textures. See page 5. All glass textures same price
- Optional clavos for lower panel: 20 clavos add \$220
- Optional Brick Mold trim to exterior side: add \$122
- Optional ADA Threshold: add \$90
- Optional construction doors and hinges: Hollow \$750 Solid \$1,250 (set of 2)
- Optional Hold Open arm (set of 2) \$90
- Optional Screens (set of 2): \$295



Full Lite Single WI-Series Entry Doors · 8'0" Tall x 36"/42"



Barcelona®*

Shown above with Oil Rubbed Bronze Satin finish and Rain glass texture.



Bellagio*

Shown above with Black Satin finish and Reeds glass texture.

WI-Series Full Lite Single Door					
Jamb width	Active Door Handing	Doors width	Item Number	List Price Estate	List Price Artisan
4-5/8"	Right Hand	36"	BFI8BR4R	\$4,500	\$5,100
		42"	BFI84BR4R	\$4,950	\$5,550
	Left Hand	36"	BFI8BR4L	\$4,500	\$5,100
		42"	BFI84BR4L	\$4,950	\$5,550
6-5/8"	Right Hand	36"	BFI8BR6R	\$4,630	\$5,230
		42"	BFI84BR6R	\$5,100	\$5,700
	Left hand	36"	BFI8BR6L	\$4,630	\$5,230
		42"	BFI84BR6L	\$5,100	\$5,700

WI-Series Full Lite Single Door					
Jamb width	Active Door Handing	Doors width	Item Number	List Price Estate	List Price Artisan
4-5/8"	Right Hand	36"	BFI8B4R	\$4,500	\$5,100
		42"	BFI84B4R	\$4,950	\$5,550
	Left Hand	36"	BFI8B4L	\$4,500	\$5,100
		42"	BFI84B4L	\$4,950	\$5,550
6-5/8"	Right Hand	36"	BFI8B6R	\$4,630	\$5,230
		42"	BFI84B6R	\$5,100	\$5,700
	Left hand	36"	BFI8B6L	\$4,630	\$5,230
		42"	BFI84B6L	\$5,100	\$5,700

Available Options:

2 jamb widths: 4-9/16" and 6-9/16" nominal
 2 door widths: 36" or 42"
 Inswing or Outswing
 10 Factory Pre-finished Options. Add "A" after stock number for Artisan finish
 6 Glass Textures. See page 5. All glass textures same price
 Optional Brick Mold trim to exterior side: Add \$104 for 36" door, \$122 for 42" door
 Optional ADA Threshold: add \$45
 Optional Screen: \$189
 Optional Hold Open Arms: \$45

Available Options:

2 jamb widths: 4-9/16" and 6-9/16" nominal
 2 door widths: 36" or 42"
 Inswing or Outswing
 10 Factory Pre-finished Options. Add "A" after stock number for Artisan finish
 6 Glass Textures. See page 5. All glass textures same price
 Optional Brick Mold trim to exterior side: Add \$104 for 36" door, \$122 for 42" door
 Optional ADA Threshold: add \$45
 Optional Screen: \$189
 Optional Hold Open Arms: \$45



See page 8 for detailed size specifications.

* Grille design orientation: Barcelona and Bellagio single door designs are shown with Right Handed doors. Left Handed grille doors have a reversed grille pattern.



Full Lite Single WI-Series Entry Doors · 8'0" Tall x 36"/42"



Marbella®

Shown above with Black Satin finish and Ice Flower glass texture.



Milano®

Shown above with Black Satin finish and Rain glass.

WI-Series Full Lite Single Door					
Jamb width	Active Door Handing	Doors width	Item Number	List Price Estate	List Price Artisan
4-5/8"	Right Hand	36"	BF18MB4R	\$4,500	\$5,100
		42"	BF184MB4R	\$4,950	\$5,550
	Left Hand	36"	BF18MB4L	\$4,500	\$5,100
		42"	BF184MB4L	\$4,950	\$5,550
6-5/8"	Right Hand	36"	BF18MB6R	\$4,630	\$5,230
		42"	BF184MB6R	\$5,100	\$5,700
	Left hand	36"	BF18MB6L	\$4,630	\$5,230
		42"	BF184MB6L	\$5,100	\$5,700

Available Options:

2 jamb widths: 4-9/16" and 6-9/16" nominal
 2 door widths: 36" or 42"
 Inswing or Outswing
 10 Factory Pre-finished Options. Add "A" after stock number for Artisan finish
 6 Glass Textures. See page 5. All glass textures same price
 Optional Brick Mold trim to exterior side: Add \$104 for 36" door, \$122 for 42" door
 Optional ADA Threshold: add \$45
 Optional Screen: \$189
 Optional Hold Open Arms: \$45

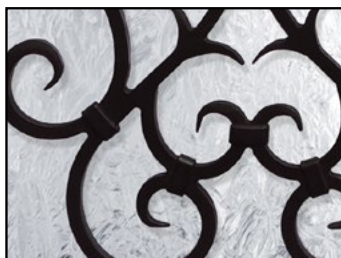

WI-Series Full Lite Single Door					
Jamb width	Active Door Handing	Doors width	Item Number	List Price Estate	List Price Artisan
4-5/8"	Right Hand	36"	BF18M4R	\$4,500	\$5,100
		42"	BF184M4R	\$4,950	\$5,550
	Left Hand	36"	BF18M4L	\$4,500	\$5,100
		42"	BF184M4L	\$4,950	\$5,550
6-5/8"	Right Hand	36"	BF18M6R	\$4,630	\$5,230
		42"	BF184M6R	\$5,100	\$5,700
	Left hand	36"	BF18M6L	\$4,630	\$5,230
		42"	BF184M6L	\$5,100	\$5,700

Available Options:

2 jamb widths: 4-9/16" and 6-9/16" nominal
 2 door widths: 36" or 42"
 Inswing or Outswing
 10 Factory Pre-finished Options. Add "A" after stock number for Artisan finish
 6 Glass Textures. See page 5. All glass textures same price
 Optional Brick Mold trim to exterior side: Add \$104 for 36" door, \$122 for 42" door
 Optional ADA Threshold: add \$45
 Optional Screen: \$189
 Optional Hold Open Arms: \$45



Full Lite Single WI-Series Entry Doors · 8'0" Tall x 36"/42"



Tivoli

Shown above with Black Satin finish and Ocean glass texture.



Valencia

Shown above with Black Satin finish and Clear glass.

WI-Series Full Lite Single Door					
Jamb width	Active Door Handing	Doors width	Item Number	List Price Estate	List Price Artisan
4-5/8"	Right Hand	36"	BF18TV4R	\$4,500	\$5,100
		42"	BF184TV4R	\$4,950	\$5,550
	Left Hand	36"	BF18TV4L	\$4,500	\$5,100
		42"	BF184TV4L	\$4,950	\$5,550
6-5/8"	Right Hand	36"	BF18TV6R	\$4,630	\$5,230
		42"	BF184TV6R	\$5,100	\$5,700
	Left hand	36"	BF18TV6L	\$4,630	\$5,230
		42"	BF184TV6L	\$5,100	\$5,700

WI-Series Full Lite Single Door					
Jamb width	Active Door Handing	Doors width	Item Number	List Price Estate	List Price Artisan
4-5/8"	Right Hand	36"	BF18V4R	\$4,500	\$5,100
		42"	BF184V4R	\$4,950	\$5,550
	Left Hand	36"	BF18V4L	\$4,500	\$5,100
		42"	BF184V4L	\$4,950	\$5,550
6-5/8"	Right Hand	36"	BF18V6R	\$4,630	\$5,230
		42"	BF184V6R	\$5,100	\$5,700
	Left hand	36"	BF18V6L	\$4,630	\$5,230
		42"	BF184V6L	\$5,100	\$5,700

Available Options:

2 jamb widths: 4-9/16" and 6-9/16" nominal
 2 door widths: 36" or 42"
 Inswing or Outswing
 10 Factory Pre-finished Options. Add "A" after stock number for Artisan finish
 6 Glass Textures. See page 5. All glass textures same price
 Optional Brick Mold trim to exterior side: Add \$104 for 36" door, \$122 for 42" door
 Optional ADA Threshold: add \$45
 Optional Screen: \$189
 Optional Hold Open Arms: \$45

Available Options:

2 jamb widths: 4-9/16" and 6-9/16" nominal
 2 door widths: 36" or 42"
 Inswing or Outswing
 10 Factory Pre-finished Options. Add "A" after stock number for Artisan finish
 6 Glass Textures. See page 5. All glass textures same price
 Optional Brick Mold trim to exterior side: Add \$104 for 36" door, \$122 for 42" door
 Optional ADA Threshold: add \$45
 Optional Screen: \$189
 Optional Hold Open Arms: \$45

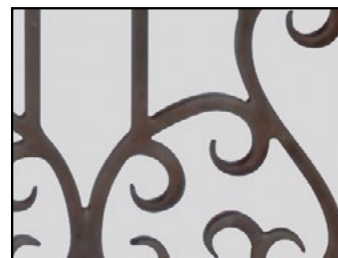
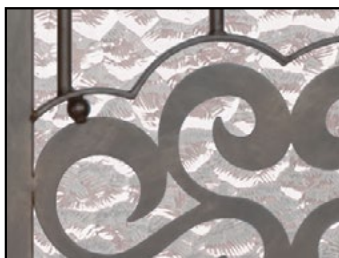

3/4 Lite Single WI-Series Entry Doors · 8'0" Tall x 36"/42"



Barcelona®*

Shown above with French Grey Satin finish and Reeds glass texture.



Marbella®

Shown above with Oil Rubbed Bronze Satin finish and Ocean glass texture.

WI-Series 3/4 Lite Single Door					
Jamb width	Active Door Handing	Doors width	Item Number	List Price Estate	List Price Artisan
4-5/8"	Right Hand	36"	BFI834BR4R	\$4,850	\$5,450
		42"	BFI8434BR4R	\$5,250	\$5,850
	Left Hand	36"	BFI834BR4L	\$4,850	\$5,450
		42"	BFI8434BR4L	\$5,250	\$5,850
6-5/8"	Right Hand	36"	BFI834BR6R	\$4,980	\$5,580
		42"	BFI8434BR6R	\$5,400	\$6,000
	Left hand	36"	BFI834BR6L	\$4,980	\$5,580
		42"	BFI8434BR6L	\$5,400	\$6,000

Available Options:

2 jamb widths: 4-9/16" and 6-9/16" nominal Inswing or Outswing
 2 door widths: 36" or 42"
 10 Factory Pre-finished Options. Add "A" after stock number for Artisan finish
 6 Glass Textures. See page 5. All glass textures same price
 Optional clavos for lower panel: 10 clavos add \$110
 Optional Brick Mold trim to exterior side: Add \$104 for 36" door, \$122 for 42" door
 Optional ADA Threshold: add \$45
 Optional Screen: add \$148
 Optional Hold Open Arm: add \$45
 Optional Strike Jamb Reinforcement: add \$90

WI-Series 3/4 Lite Single Door					
Jamb width	Active Door Handing	Doors width	Item Number	List Price Estate	List Price Artisan
4-5/8"	Right Hand	36"	BFI834MB4R	\$4,850	\$5,450
		42"	BFI8434MB4R	\$5,250	\$5,850
	Left Hand	36"	BFI834MB4L	\$4,850	\$5,450
		42"	BFI8434MB4L	\$5,250	\$5,850
6-5/8"	Right Hand	36"	BFI834MB6R	\$4,980	\$5,580
		42"	BFI8434MB6R	\$5,400	\$6,000
	Left hand	36"	BFI834MB6L	\$4,980	\$5,580
		42"	BFI8434MB6L	\$5,400	\$6,000

Available Options:

2 jamb widths: 4-9/16" and 6-9/16" nominal Inswing or Outswing
 2 door widths: 36" or 42"
 10 Factory Pre-finished Options. Add "A" after stock number for Artisan finish
 6 Glass Textures. See page 5. All glass textures same price
 Optional clavos for lower panel: 10 clavos add \$110
 Optional Brick Mold trim to exterior side: Add \$104 for 36" door, \$122 for 42" door
 Optional ADA Threshold: add \$45
 Optional Screen: add \$148
 Optional Hold Open Arm: add \$45
 Optional Strike Jamb Reinforcement: add \$90



See page 8 for detailed size specifications.

* Grille design orientation: Barcelona and Bellagio single door designs are shown with Right Handed doors. Left Handed grille doors have a reversed grille pattern.



3/4 Lite Single WI-Series Entry Doors · 8'0" Tall x 36"/42"



Tivoli

Shown above with Black Satin finish and Rain glass texture.



Valencia

Shown above with Oil Rubbed Bronze Satin finish and Ice Flower glass texture.

WI-Series 3/4 Lite Single Door					
Jamb width	Active Door Handing	Doors width	Item Number	List Price Estate	List Price Artisan
4-5/8"	Right Hand	36"	BF1834TV4R	\$4,850	\$5,450
		42"	BF18434TV4R	\$5,250	\$5,850
	Left Hand	36"	BF1834TV4L	\$4,850	\$5,450
		42"	BF18434TV4L	\$5,250	\$5,850
6-5/8"	Right Hand	36"	BF1834TV6R	\$4,980	\$5,580
		42"	BF18434TV6R	\$5,400	\$6,000
	Left hand	36"	BF1834TV6L	\$4,980	\$5,580
		42"	BF18434TV6L	\$5,400	\$6,000

WI-Series 3/4 Lite Single Door					
Jamb width	Active Door Handing	Doors width	Item Number	List Price Estate	List Price Artisan
4-5/8"	Right Hand	36"	BF1834V4R	\$4,850	\$5,450
		42"	BF18434V4R	\$5,250	\$5,850
	Left Hand	36"	BF1834V4L	\$4,850	\$5,450
		42"	BF18434V4L	\$5,250	\$5,850
6-5/8"	Right Hand	36"	BF1834V6R	\$4,980	\$5,580
		42"	BF18434V6R	\$5,400	\$6,000
	Left hand	36"	BF1834V6L	\$4,980	\$5,580
		42"	BF18434V6L	\$5,400	\$6,000

Available Options:

2 jamb widths: 4-9/16" and 6-9/16" nominal Inswing or Outswing
 2 door widths: 36" or 42"
 10 Factory Pre-finished Options. Add "A" after stock number for Artisan finish
 6 Glass Textures. See page 5. All glass textures same price
 Optional clavos for lower panel: 10 clavos add \$110
 Optional Brick Mold trim to exterior side: Add \$104 for 36" door, \$122 for 42" door
 Optional ADA Threshold: add \$45
 Optional Screen: add \$148
 Optional Hold Open Arm: add \$45
 Optional Strike Jamb Reinforcement: add \$90

Available Options:

2 jamb widths: 4-9/16" and 6-9/16" nominal Inswing or Outswing
 2 door widths: 36" or 42"
 10 Factory Pre-finished Options. Add "A" after stock number for Artisan finish
 6 Glass Textures. See page 5. All glass textures same price
 Optional clavos for lower panel: 10 clavos add \$110
 Optional Brick Mold trim to exterior side: Add \$104 for 36" door, \$122 for 42" door
 Optional ADA Threshold: add \$45
 Optional Screen: add \$148
 Optional Hold Open Arm: add \$45
 Optional Strike Jamb Reinforcement: add \$90

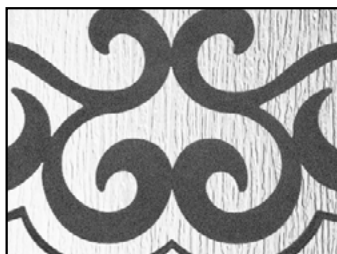



Contemporary CD-Series Doors

GlassCraft's CD-Series in the Buffalo Forge ThermaPremium line features 7 unique contemporary designs made of precision-engineered, plasma-cut steel grilles. Perfect for the modern home, mid-century, or transitional architecture. Each door unit in this series is premium in every detail and creates an impressive curb appeal unlike any other in the market. Complement these premium entryways with your choice of handle sets, finishes and glass textures.

Photo: Shown with the Cube CD-Series design in full lite double square top configuration with Cloud glass, and Lumina handle sets.

CD-SERIES CONTEMPORARY DOORS

8'0" BUFFALO FORGE THERMAPREMIUM STEEL ENTRY DOORS

CD-SERIES 8'0" TALL BUFFALO FORGE STEEL DOORS



7 CD-Series Designs

Urban-4, Urban-5, Minimal, Eclectic, Cube, Arte, and Moderne. See pg. 42 for details.

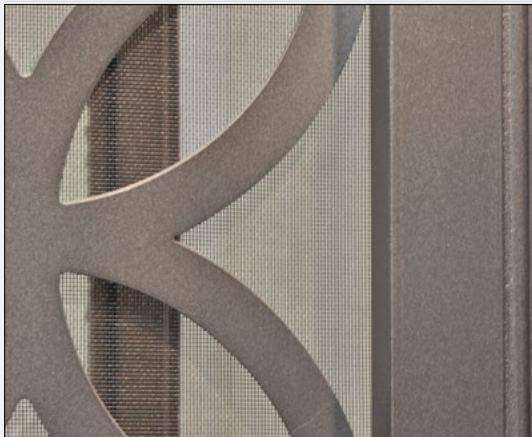

OPTIONAL SCREEN allows for ventilation with the operable glass panels. Screens seamlessly blend with the doors without obstruction to the design or function.

Unique features of GlassCraft's CD-Series

- All doors in this section feature operable inner glass doors for security and ventilation.
- Patented Thermal-Break design
- Unique face-mounted frame system that gives the look of a raised-moulding detail for enhanced architectural definition on the exterior of the door.
- Unique Plasma-Cut steel grilles incorporate unique modern designs that utilize thick 14-gauge steel.
- Each unit is pre-assembled and installed into a test wall to ensure hassle-free onsite installation.
- Unique heavy-duty hinges for long-lasting use (see page 11).
- Six different glass textures are available (page 5).
- A wide variety handlesets are available (see pages 14-15) or use your own door hardware. Doors are a full 1-3/4" thick and can use any standard door entrysets.
- Fifteen different finish colors are available (see page 7).
- Endura solid composite thresholds may be adjusted to ensure a weatherproof seal. Other brands use cheap hollow sills that can dent and are not adjustable.
- Double Insulated glass panels that are energy efficient and thermally insulating.



WINDSTORM RATED and Certified CD-Series Doors

All CD-Series entryway designs have been certified by an independent laboratory to be windstorm approved. Please refer to our website for specific DP Ratings or design pressure certifications for each Buffalo Forge entry door configuration.

Entryway Configurations

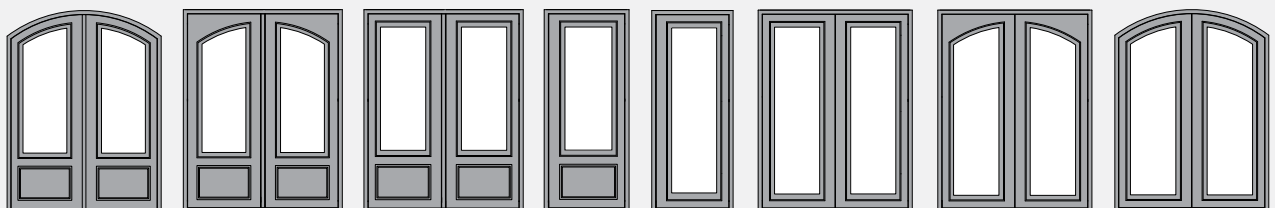



7 Grille Designs

Precision-cut designs using 14 gauge premium quality steel.



Moderne

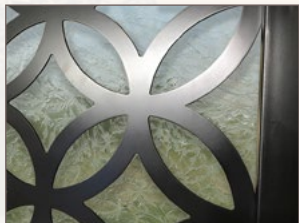

Eclectic



Minimal

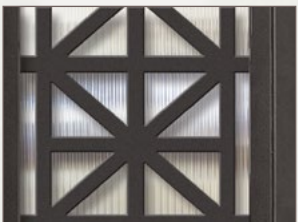

Contempo

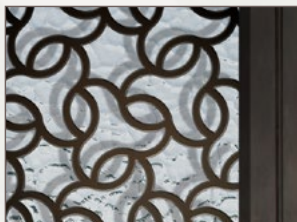

Arte

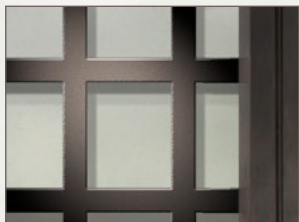

Cube

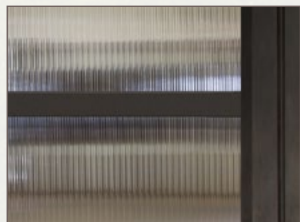

Urban

3/4 Lite Arch Top Double CD-Series Entry Doors · 8'0" Tall



Urban-4 3/4 Arch Top Double

Shown above with French Grey Satin finish and Rain glass texture.



Urban-5 3/4 Arch Top Double

Shown above with French Grey Satin finish and Rain glass. Lumina door hardware with matching dummy on inactive door.

CD-Series 3/4 Arch Top Double Door					
Jamb width	Active Door Handing	Doors width	Item Number	List Price Estate	List Price Artisan
4-5/8"	Right Hand	36"	BFC834ATDU4L4R	\$8,730	\$9,930
	Left Hand	36"	BFC834ATDU4L4L	\$8,730	\$9,930
6-5/8"	Right Hand	36"	BFC834ATDU4L6R	\$9,015	\$10,215
	Left hand	36"	BFC834ATDU4L6L	\$9,015	\$10,215

Available Options:

- 2 jamb widths: 4-9/16" and 6-9/16" nominal
- 1 door width: 36"
- Inswing or Outswing
- 10 Factory Pre-finished Options. Add "A" after stock number for Artisan finish
- 6 Glass Textures. See page 5. All glass textures same price
- Optional clavos for lower panel: 20 clavos add \$220
- Optional Brick Mold trim to exterior side: add \$336
- Optional ADA Threshold: add \$90
- Optional construction doors and hinges: Hollow \$750 Solid \$1,250 (set of 2)
- Optional Screens (set of 2): \$466
- Optional Hold Open arm (set of 2) \$90



CD-Series 3/4 Arch Top Double Door					
Jamb width	Active Door Handing	Doors width	Item Number	List Price Estate	List Price Artisan
4-5/8"	Right Hand	36"	BFC834ATDU5L4R	\$8,730	\$9,930
	Left Hand	36"	BFC834ATDU5L4L	\$8,730	\$9,930
6-5/8"	Right Hand	36"	BFC834ATDU5L6R	\$9,015	\$10,215
	Left hand	36"	BFC834ATDU5L6L	\$9,015	\$10,215

Available Options:

- 2 jamb widths: 4-9/16" and 6-9/16" nominal
- 1 door width: 36"
- Inswing or Outswing
- 10 Factory Pre-finished Options. Add "A" after stock number for Artisan finish
- 6 Glass Textures. See page 5. All glass textures same price
- Optional clavos for lower panel: 20 clavos add \$220
- Optional Brick Mold trim to exterior side: add \$336
- Optional ADA Threshold: add \$90
- Optional construction doors and hinges: Hollow \$750 Solid \$1,250 (set of 2)
- Optional Screens (set of 2): \$466
- Optional Hold Open arm (set of 2) \$90

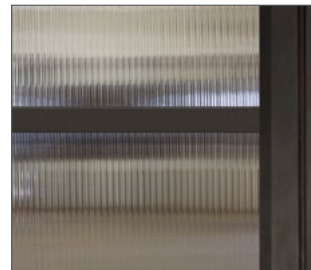

3/4 Lite Arch Top Double CD-Series Entry Doors · 8'0" Tall



Minimal 3/4 Arch Top Double

Shown above with French Grey Satin finish and Rain glass texture.



Eclectic 3/4 Arch Top Double

Shown above with Oil Rubbed Bronze Satin finish and Ice Flower glass texture.

CD-Series 3/4 Arch Top Double Door					
Jamb width	Active Door Handing	Doors width	Item Number	List Price Estate	List Price Artisan
4-5/8"	Right Hand	36"	BFC834ATDMN4R	\$8,730	\$9,930
	Left Hand	36"	BFC834ATDMN4L	\$8,730	\$9,930
6-5/8"	Right Hand	36"	BFC834ATDMN6R	\$9,015	\$10,215
	Left hand	36"	BFC834ATDMN6L	\$9,015	\$10,215

Available Options:

- 2 jamb widths: 4-9/16" and 6-9/16" nominal
- 1 door width: 36"
- Inswing or Outswing
- 10 Factory Pre-finished Options. Add "A" after stock number for Artisan finish
- 6 Glass Textures. See page 5. All glass textures same price
- Optional clavos for lower panel: 20 clavos add \$220
- Optional Brick Mold trim to exterior side: add \$336
- Optional ADA Threshold: add \$90
- Optional construction doors and hinges: Hollow \$750 Solid \$1,250 (set of 2)
- Optional Screens (set of 2): \$466
- Optional Hold Open arm (set of 2) \$90



CD-Series 3/4 Arch Top Double Door					
Jamb width	Active Door Handing	Doors width	Item Number	List Price Estate	List Price Artisan
4-5/8"	Right Hand	36"	BFC834ATDEC4R	\$8,730	\$9,930
	Left Hand	36"	BFC834ATDEC4L	\$8,730	\$9,930
6-5/8"	Right Hand	36"	BFC834ATDEC6R	\$9,015	\$10,215
	Left hand	36"	BFC834ATDEC6L	\$9,015	\$10,215

Available Options:

- 2 jamb widths: 4-9/16" and 6-9/16" nominal
- 1 door width: 36"
- Inswing or Outswing
- 10 Factory Pre-finished Options. Add "A" after stock number for Artisan finish
- 6 Glass Textures. See page 5. All glass textures same price
- Optional clavos for lower panel: 20 clavos add \$220
- Optional Brick Mold trim to exterior side: add \$336
- Optional ADA Threshold: add \$90
- Optional construction doors and hinges: Hollow \$750 Solid \$1,250 (set of 2)
- Optional Screens (set of 2): \$466
- Optional Hold Open arm (set of 2) \$90

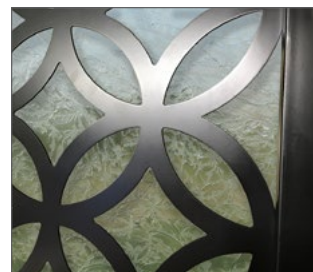

3/4 Lite Arch Top Double CD-Series Entry Doors · 8'0" Tall



Cube 3/4 Arch Top Double

Shown above with Black Satin finish and Ice Flower glass texture.



Arte 3/4 Arch Top Double

Shown above with French Grey Satin finish and Rain glass texture.

CD-Series 3/4 Arch Top Double Door					
Jamb width	Active Door Handing	Doors width	Item Number	List Price Estate	List Price Artisan
4-5/8"	Right Hand	36"	BFC834ATDCU4R	\$8,730	\$9,930
	Left Hand	36"	BFC834ATDCU4L	\$8,730	\$9,930
6-5/8"	Right Hand	36"	BFC834ATDCU6R	\$9,015	\$10,215
	Left hand	36"	BFC834ATDCU6L	\$9,015	\$10,215

Available Options:

- 2 jamb widths: 4-9/16" and 6-9/16" nominal
- 1 door width: 36"
- Inswing or Outswing
- 10 Factory Pre-finished Options. Add "A" after stock number for Artisan finish
- 6 Glass Textures. See page 5. All glass textures same price
- Optional clavos for lower panel: 20 clavos add \$220
- Optional Brick Mold trim to exterior side: add \$336
- Optional ADA Threshold: add \$90
- Optional construction doors and hinges: Hollow \$750 Solid \$1,250 (set of 2)
- Optional Screens (set of 2): \$466
- Optional Hold Open arm (set of 2) \$90

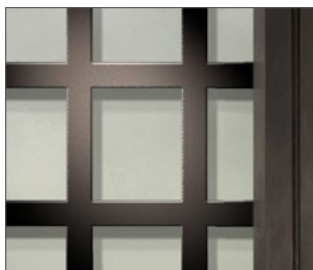

CD-Series 3/4 Arch Top Double Door					
Jamb width	Active Door Handing	Doors width	Item Number	List Price Estate	List Price Artisan
4-5/8"	Right Hand	36"	BFC834ATDAR4R	\$8,730	\$9,930
	Left Hand	36"	BFC834ATDAR4L	\$8,730	\$9,930
6-5/8"	Right Hand	36"	BFC834ATDAR6R	\$9,015	\$10,215
	Left hand	36"	BFC834ATDAR6L	\$9,015	\$10,215

Available Options:

- 2 jamb widths: 4-9/16" and 6-9/16" nominal
- 1 door width: 36"
- Inswing or Outswing
- 10 Factory Pre-finished Options. Add "A" after stock number for Artisan finish
- 6 Glass Textures. See page 5. All glass textures same price
- Optional clavos for lower panel: 20 clavos add \$220
- Optional Brick Mold trim to exterior side: add \$336
- Optional ADA Threshold: add \$90
- Optional construction doors and hinges: Hollow \$750 Solid \$1,250 (set of 2)
- Optional Screens (set of 2): \$466
- Optional Hold Open arm (set of 2) \$90

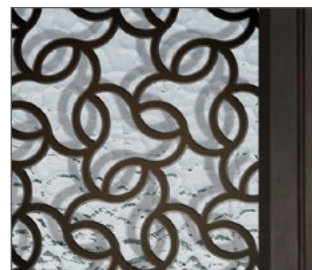

3/4 Arch Lite Double CD-Series Entry Doors · 8'0" Tall



Urban-4 3/4 Arch Lite Double

Shown above with Oil Rubbed Bronze Satin finish and Cloud glass texture. San Jose Antique Nickel handleset.



Urban-5 3/4 Arch Lite Double

Shown above with Black Satin finish and Reeds glass texture. Zenia handleset.

CD-Series 3/4 Arch Lite Double Door					
Jamb width	Active Door Handing	Doors width	Item Number	List Price Estate	List Price Artisan
4-5/8"	Right Hand	36"	BFC834STDU4L4R	\$8,640	\$9,840
	Left Hand	36"	BFC834STDU4L4L	\$8,640	\$9,840
6-5/8"	Right Hand	36"	BFC834STDU4L6R	\$8,785	\$9,985
	Left hand	36"	BFC834STDU4L6L	\$8,785	\$9,985

Available Options:

- 2 jamb widths: 4-9/16" and 6-9/16" nominal
- 1 door width: 36"
- Inswing or Outswing
- 10 Factory Pre-finished Options. Add "A" after stock number for Artisan finish
- 6 Glass Textures. See page 5. All glass textures same price
- Optional clavos for lower panel: 20 clavos add \$220
- Optional Brick Mold trim to exterior side: add \$122
- Optional ADA Threshold: add \$90
- Optional construction doors and hinges: Hollow \$750 Solid \$1,250 (set of 2)
- Optional Screens (set of 2): \$466
- Optional Hold Open arm (set of 2) \$90



CD-Series 3/4 Arch Lite Double Door					
Jamb width	Active Door Handing	Doors width	Item Number	List Price Estate	List Price Artisan
4-5/8"	Right Hand	36"	BFC834STDU5L4R	\$8,640	\$9,840
	Left Hand	36"	BFC834STDU5L4L	\$8,640	\$9,840
6-5/8"	Right Hand	36"	BFC834STDU5L6R	\$8,785	\$9,985
	Left hand	36"	BFC834STDU5L6L	\$8,785	\$9,985

Available Options:

- 2 jamb widths: 4-9/16" and 6-9/16" nominal
- 1 door width: 36"
- Inswing or Outswing
- 10 Factory Pre-finished Options. Add "A" after stock number for Artisan finish
- 6 Glass Textures. See page 5. All glass textures same price
- Optional clavos for lower panel: 20 clavos add \$220
- Optional Brick Mold trim to exterior side: add \$122
- Optional ADA Threshold: add \$90
- Optional construction doors and hinges: Hollow \$750 Solid \$1,250 (set of 2)
- Optional Screens (set of 2): \$466
- Optional Hold Open arm (set of 2) \$90

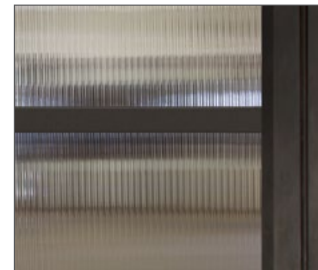

3/4 Arch Lite Double CD-Series Entry Doors · 8'0" Tall



Minimal 3/4 Arch Lite Double

Shown above with French Grey Satin finish and Rain glass texture.



Eclectic 3/4 Arch Lite Double

Shown above with Black Satin finish and Ice Flower glass texture.

CD-Series 3/4 Arch Lite Double Door					
Jamb width	Active Door Handing	Doors width	Item Number	List Price Estate	List Price Artisan
4-5/8"	Right Hand	36"	BFC834STDMN4R	\$8,640	\$9,840
	Left Hand	36"	BFC834STDMN4L	\$8,640	\$9,840
6-5/8"	Right Hand	36"	BFC834STDMN6R	\$8,785	\$9,985
	Left hand	36"	BFC834STDMN6L	\$8,785	\$9,985

CD-Series 3/4 Arch Lite Double Door					
Jamb width	Active Door Handing	Doors width	Item Number	List Price Estate	List Price Artisan
4-5/8"	Right Hand	36"	BFC834STDEC4R	\$8,640	\$9,840
	Left Hand	36"	BFC834STDEC4L	\$8,640	\$9,840
6-5/8"	Right Hand	36"	BFC834STDEC6R	\$8,785	\$9,985
	Left hand	36"	BFC834STDEC6L	\$8,785	\$9,985

Available Options:

- 2 jamb widths: 4-9/16" and 6-9/16" nominal
- 1 door width: 36"
- Inswing or Outswing
- 10 Factory Pre-finished Options. Add "A" after stock number for Artisan finish
- 6 Glass Textures. See page 5. All glass textures same price
- Optional clavos for lower panel: 20 clavos add \$220
- Optional Brick Mold trim to exterior side: add \$122
- Optional ADA Threshold: add \$90
- Optional construction doors and hinges: Hollow \$750 Solid \$1,250 (set of 2)
- Optional Screens (set of 2): \$466
- Optional Hold Open arm (set of 2) \$90



Available Options:

- 2 jamb widths: 4-9/16" and 6-9/16" nominal
- 1 door width: 36"
- Inswing or Outswing
- 10 Factory Pre-finished Options. Add "A" after stock number for Artisan finish
- 6 Glass Textures. See page 5. All glass textures same price
- Optional clavos for lower panel: 20 clavos add \$220
- Optional Brick Mold trim to exterior side: add \$122
- Optional ADA Threshold: add \$90
- Optional construction doors and hinges: Hollow \$750 Solid \$1,250 (set of 2)
- Optional Screens (set of 2): \$466
- Optional Hold Open arm (set of 2) \$90

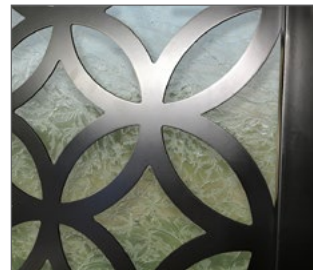

3/4 Arch Lite Double CD-Series Entry Doors · 8'0" Tall



Cube 3/4 Arch Lite Double

Shown above with Oil Rubbed Bronze Satin finish and Cloud glass texture.



Arte 3/4 Arch Lite Double

Shown above with Oil Rubbed Bronze Satin finish and Ocean glass texture.

CD-Series 3/4 Arch Lite Double Door					
Jamb width	Active Door Handing	Doors width	Item Number	List Price Estate	List Price Artisan
4-5/8"	Right Hand	36"	BFC834STDCU4R	\$8,640	\$9,840
	Left Hand	36"	BFC834STDCU4L	\$8,640	\$9,840
6-5/8"	Right Hand	36"	BFC834STDCU6R	\$8,785	\$9,985
	Left hand	36"	BFC834STDCU6L	\$8,785	\$9,985

Available Options:

2 jamb widths: 4-9/16" and 6-9/16" nominal
 1 door width: 36"
 Inswing or Outswing
 10 Factory Pre-finished Options. Add "A" after stock number for Artisan finish
 6 Glass Textures. See page 5. All glass textures same price
 Optional clavos for lower panel: 20 clavos add \$220
 Optional Brick Mold trim to exterior side: add \$122
 Optional ADA Threshold: add \$90
 Optional construction doors and hinges: Hollow \$750 Solid \$1,250 (set of 2)
 Optional Screens (set of 2): \$466
 Optional Hold Open arm (set of 2) \$90

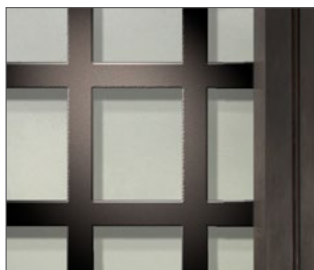

CD-Series 3/4 Arch Lite Double Door					
Jamb width	Active Door Handing	Doors width	Item Number	List Price Estate	List Price Artisan
4-5/8"	Right Hand	36"	BFC834STDAR4R	\$8,640	\$9,840
	Left Hand	36"	BFC834STDAR4L	\$8,640	\$9,840
6-5/8"	Right Hand	36"	BFC834STDAR6R	\$8,785	\$9,985
	Left hand	36"	BFC834STDAR6L	\$8,785	\$9,985

Available Options:

2 jamb widths: 4-9/16" and 6-9/16" nominal
 1 door width: 36"
 Inswing or Outswing
 10 Factory Pre-finished Options. Add "A" after stock number for Artisan finish
 6 Glass Textures. See page 5. All glass textures same price
 Optional clavos for lower panel: 20 clavos add \$220
 Optional Brick Mold trim to exterior side: add \$122
 Optional ADA Threshold: add \$90
 Optional construction doors and hinges: Hollow \$750 Solid \$1,250 (set of 2)
 Optional Screens (set of 2): \$466
 Optional Hold Open arm (set of 2) \$90

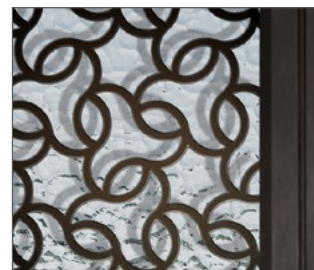

Arch Top Double CD-Series Entry Doors · 8'0" Tall



Urban-4 Arch Top Double

Shown above with Black Satin finish and Clear glass.



Urban-5 Arch Top Double

Shown above with ORB Bronze Satin finish and Reeds glass texture.

CD-Series Arch Top Double Door					
Jamb width	Active Door Handing	Doors width	Item Number	List Price Estate	List Price Artisan
4-5/8"	Right Hand	36"	BFC8ATDU4L4R	\$8,460	\$9,660
	Left Hand	36"	BFC8ATDU4L4L	\$8,460	\$9,660
6-5/8"	Right Hand	36"	BFC8ATDU4L6R	\$8,745	\$9,945
	Left hand	36"	BFC8ATDU4L6L	\$8,745	\$9,945

Available Options:

- 2 jamb widths: 4-9/16" and 6-9/16" nominal
- 1 door width: 36"
- Inswing or Outswing
- 10 Factory Pre-finished Options. Add "A" after stock number for Artisan finish
- 6 Glass Textures. See page 5. All glass textures same price
- Optional Brick Mold trim to exterior side: add \$336
- Optional ADA Threshold: add \$90
- Optional construction doors and hinges: Hollow \$750 Solid \$1,250 (set of 2)
- Optional Screens (set of 2): \$548
- Optional Hold Open arm (set of 2) \$90



CD-Series Arch Top Double Door					
Jamb width	Active Door Handing	Doors width	Item Number	List Price Estate	List Price Artisan
4-5/8"	Right Hand	36"	BFC8ATDU5L4R	\$8,460	\$9,660
	Left Hand	36"	BFC8ATDU5L4L	\$8,460	\$9,660
6-5/8"	Right Hand	36"	BFC8ATDU5L6R	\$8,745	\$9,945
	Left hand	36"	BFC8ATDU5L6L	\$8,745	\$9,945

Available Options:

- 2 jamb widths: 4-9/16" and 6-9/16" nominal
- 1 door width: 36"
- Inswing or Outswing
- 10 Factory Pre-finished Options. Add "A" after stock number for Artisan finish
- 6 Glass Textures. See page 5. All glass textures same price
- Optional Brick Mold trim to exterior side: add \$336
- Optional ADA Threshold: add \$90
- Optional construction doors and hinges: Hollow \$750 Solid \$1,250 (set of 2)
- Optional Screens (set of 2): \$548
- Optional Hold Open arm (set of 2) \$90

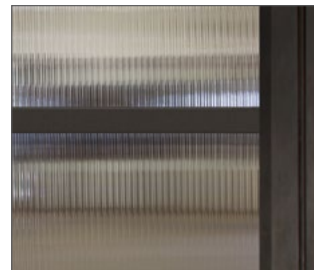

Arch Top Double CD-Series Entry Doors · 8'0" Tall



Minimal Arch Top Double

Shown above with French Grey Satin finish and Ocean glass texture.

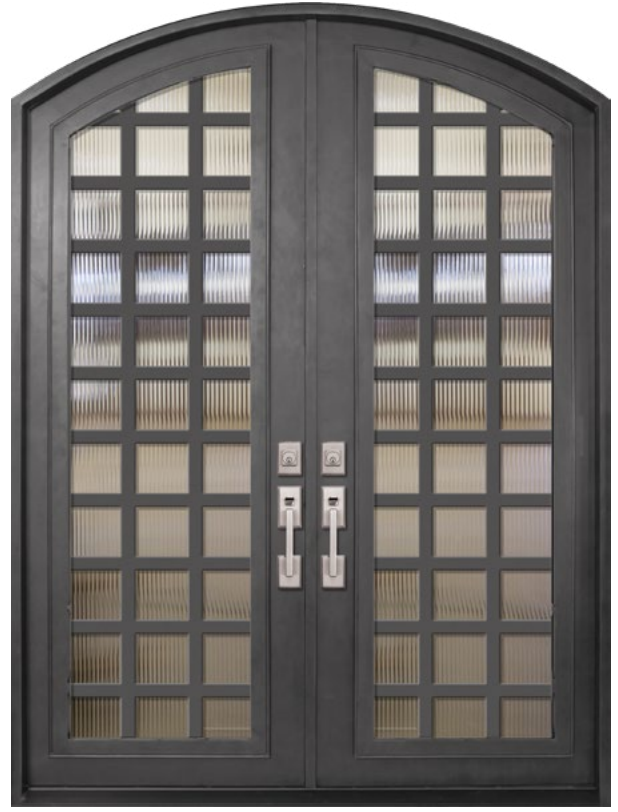

Cube Arch Top Double

Shown above with French Grey Satin finish and Reeds glass texture.

CD-Series Arch Top Double Door					
Jamb width	Active Door Handing	Doors width	Item Number	List Price Estate	List Price Artisan
4-5/8"	Right Hand	36"	BFC8ATDMN4R	\$8,460	\$9,660
	Left Hand	36"	BFC8ATDMN4L	\$8,460	\$9,660
6-5/8"	Right Hand	36"	BFC8ATDMN6R	\$8,745	\$9,945
	Left hand	36"	BFC8ATDMN6L	\$8,745	\$9,945

Available Options:

- 2 jamb widths: 4-9/16" and 6-9/16" nominal
- 1 door width: 36"
- Inswing or Outswing
- 10 Factory Pre-finished Options. Add "A" after stock number for Artisan finish
- 6 Glass Textures. See page 5. All glass textures same price
- Optional Brick Mold trim to exterior side: add \$336
- Optional ADA Threshold: add \$90
- Optional construction doors and hinges: Hollow \$750 Solid \$1,250 (set of 2)
- Optional Screens (set of 2): \$548
- Optional Hold Open arm (set of 2) \$90

CD-Series Arch Top Double Door					
Jamb width	Active Door Handing	Doors width	Item Number	List Price Estate	List Price Artisan
4-5/8"	Right Hand	36"	BFC8ATDCU4R	\$8,460	\$9,660
	Left Hand	36"	BFC8ATDCU4L	\$8,460	\$9,660
6-5/8"	Right Hand	36"	BFC8ATDCU6R	\$8,745	\$9,945
	Left hand	36"	BFC8ATDCU6L	\$8,745	\$9,945

Available Options:

- 2 jamb widths: 4-9/16" and 6-9/16" nominal
- 1 door width: 36"
- Inswing or Outswing
- 10 Factory Pre-finished Options. Add "A" after stock number for Artisan finish
- 6 Glass Textures. See page 5. All glass textures same price
- Optional Brick Mold trim to exterior side: add \$336
- Optional ADA Threshold: add \$90
- Optional construction doors and hinges: Hollow \$750 Solid \$1,250 (set of 2)
- Optional Screens (set of 2): \$548
- Optional Hold Open arm (set of 2) \$90



Arch Top Double CD-Series Entry Doors · 8'0" Tall



Eclectic Arch Top Double

Shown above with Medium Grey Satin finish and Rain glass texture.



Arte Arch Top Double

Shown above with Medium Bronze Satin finish and Clear glass.

CD-Series Arch Top Double Door					
Jamb width	Active Door Handing	Doors width	Item Number	List Price Estate	List Price Artisan
4-5/8"	Right Hand	36"	BFC8ATDEC4R	\$8,460	\$9,660
	Left Hand	36"	BFC8ATDEC4L	\$8,460	\$9,660
6-5/8"	Right Hand	36"	BFC8ATDEC6R	\$8,745	\$9,945
	Left hand	36"	BFC8ATDEC6L	\$8,745	\$9,945

Available Options:

- 2 jamb widths: 4-9/16" and 6-9/16" nominal
- 1 door width: 36"
- Inswing or Outswing
- 10 Factory Pre-finished Options. Add "A" after stock number for Artisan finish
- 6 Glass Textures. See page 5. All glass textures same price
- Optional Brick Mold trim to exterior side: add \$336
- Optional ADA Threshold: add \$90
- Optional construction doors and hinges: Hollow \$750 Solid \$1,250 (set of 2)
- Optional Screens (set of 2): \$548
- Optional Hold Open arm (set of 2) \$90

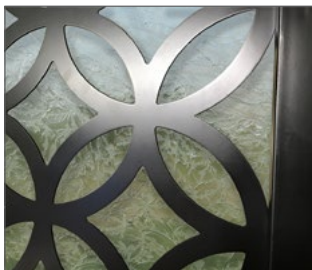

CD-Series Arch Top Double Door					
Jamb width	Active Door Handing	Doors width	Item Number	List Price Estate	List Price Artisan
4-5/8"	Right Hand	36"	BFC8ATDAR4R	\$8,460	\$9,660
	Left Hand	36"	BFC8ATDAR4L	\$8,460	\$9,660
6-5/8"	Right Hand	36"	BFC8ATDAR6R	\$8,745	\$9,945
	Left hand	36"	BFC8ATDAR6L	\$8,745	\$9,945

Available Options:

- 2 jamb widths: 4-9/16" and 6-9/16" nominal
- 1 door width: 36"
- Inswing or Outswing
- 10 Factory Pre-finished Options. Add "A" after stock number for Artisan finish
- 6 Glass Textures. See page 5. All glass textures same price
- Optional Brick Mold trim to exterior side: add \$336
- Optional ADA Threshold: add \$90
- Optional construction doors and hinges: Hollow \$750 Solid \$1,250 (set of 2)
- Optional Screens (set of 2): \$548
- Optional Hold Open arm (set of 2) \$90

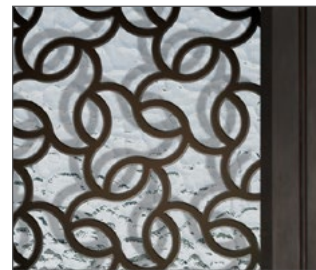

Arch Lite Double CD-Series Entry Doors · 8'0" Tall



Urban-4 Arch Lite Double

Shown above with Black Satin finish
and Rain glass texture.



Urban-5 Arch Lite Double

Shown above with Oil Rubbed Bronze Satin finish
and Cloud glass texture.

CD-Series Arch Lite Double Door					
Jamb width	Active Door Handing	Doors width	Item Number	List Price Estate	List Price Artisan
4-5/8"	Right Hand	36"	BFC8STDU4L4R	\$8,360	\$9,570
	Left Hand	36"	BFC8STDU4L4L	\$8,360	\$9,570
6-5/8"	Right Hand	36"	BFC8STDU4L6R	\$8,505	\$9,705
	Left hand	36"	BFC8STDU4L6L	\$8,505	\$9,705

Available Options:

2 jamb widths: 4-9/16" and 6-9/16" nominal
 1 door width: 36"
 Inswing or Outswing
 10 Factory Pre-finished Options. Add "A" after stock number for Artisan finish
 6 Glass Textures. See page 5. All glass textures same price
 Optional Brick Mold trim to exterior side: add \$122
 Optional ADA Threshold: add \$90
 Optional construction doors and hinges: Hollow \$750 Solid \$1,250 (set of 2)
 Optional Screens (set of 2): \$548
 Optional Hold Open arm (set of 2) \$90

CD-Series Arch Lite Double Door					
Jamb width	Active Door Handing	Doors width	Item Number	List Price Estate	List Price Artisan
4-5/8"	Right Hand	36"	BFC8STDU5L4R	\$8,360	\$9,570
	Left Hand	36"	BFC8STDU5L4L	\$8,360	\$9,570
6-5/8"	Right Hand	36"	BFC8STDU5L6R	\$8,505	\$9,705
	Left hand	36"	BFC8STDU5L6L	\$8,505	\$9,705

Available Options:

2 jamb widths: 4-9/16" and 6-9/16" nominal
 1 door width: 36"
 Inswing or Outswing
 10 Factory Pre-finished Options. Add "A" after stock number for Artisan finish
 6 Glass Textures. See page 5. All glass textures same price
 Optional Brick Mold trim to exterior side: add \$122
 Optional ADA Threshold: add \$90
 Optional construction doors and hinges: Hollow \$750 Solid \$1,250 (set of 2)
 Optional Screens (set of 2): \$548
 Optional Hold Open arm (set of 2) \$90

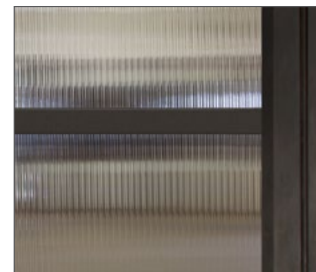

Arch Lite Double CD-Series Entry Doors · 8'0" Tall



Minimal Arch Lite Double

Shown above with French Grey Satin finish and Clear glass texture.



Cube Arch Lite Double

Shown above with Black Satin finish and Rain glass texture.

CD-Series Arch Lite Double Door					
Jamb width	Active Door Handing	Doors width	Item Number	List Price Estate	List Price Artisan
4-5/8"	Right Hand	36"	BFC8STDMN4R	\$8,360	\$9,570
	Left Hand	36"	BFC8STDMN4L	\$8,360	\$9,570
6-5/8"	Right Hand	36"	BFC8STDMN6R	\$8,505	\$9,705
	Left hand	36"	BFC8STDMN6L	\$8,505	\$9,705

Available Options:

2 jamb widths: 4-9/16" and 6-9/16" nominal
 1 door width: 36"
 Inswing or Outswing
 10 Factory Pre-finished Options. Add "A" after stock number for Artisan finish
 6 Glass Textures. See page 5. All glass textures same price
 Optional Brick Mold trim to exterior side: add \$122
 Optional ADA Threshold: add \$90
 Optional construction doors and hinges: Hollow \$750 Solid \$1,250 (set of 2)
 Optional Screens (set of 2): \$548
 Optional Hold Open arm (set of 2) \$90



CD-Series Arch Lite Double Door					
Jamb width	Active Door Handing	Doors width	Item Number	List Price Estate	List Price Artisan
4-5/8"	Right Hand	36"	BFC8STDCU4R	\$8,360	\$9,570
	Left Hand	36"	BFC8STDCU4L	\$8,360	\$9,570
6-5/8"	Right Hand	36"	BFC8STDCU6R	\$8,505	\$9,705
	Left hand	36"	BFC8STDCU6L	\$8,505	\$9,705

Available Options:

2 jamb widths: 4-9/16" and 6-9/16" nominal
 1 door width: 36"
 Inswing or Outswing
 10 Factory Pre-finished Options. Add "A" after stock number for Artisan finish
 6 Glass Textures. See page 5. All glass textures same price
 Optional Brick Mold trim to exterior side: add \$122
 Optional ADA Threshold: add \$90
 Optional construction doors and hinges: Hollow \$750 Solid \$1,250 (set of 2)
 Optional Screens (set of 2): \$548
 Optional Hold Open arm (set of 2) \$90

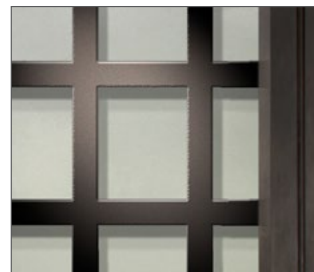

Arch Lite Double CD-Series Entry Doors · 8'0" Tall

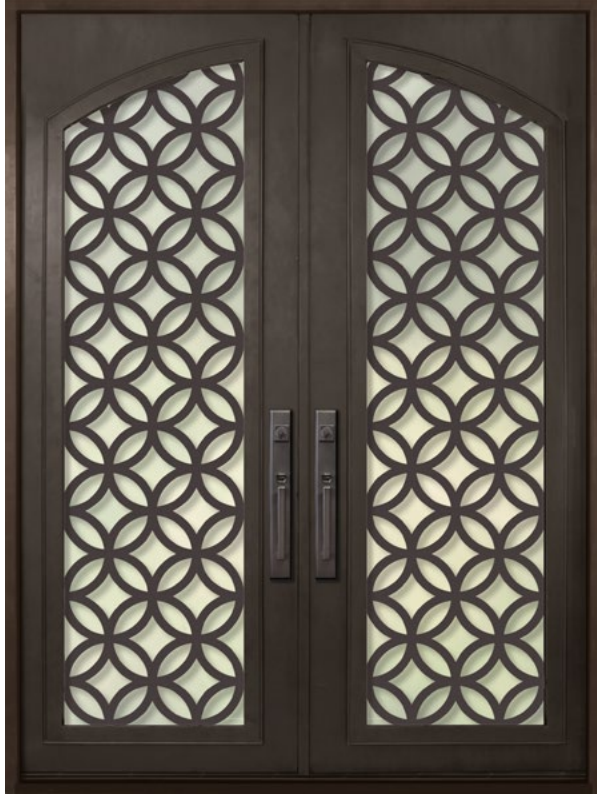

Eclectic Arch Lite Double

Shown above with Oil Rubbed Bronze Satin finish and Cloud glass texture.



Arte Arch Lite Double

Shown above with Oil Rubbed Bronze Satin finish and Ocean glass texture.

CD-Series Arch Lite Double Door					
Jamb width	Active Door Handing	Doors width	Item Number	List Price Estate	List Price Artisan
4-5/8"	Right Hand	36"	BFC8STDEC4R	\$8,360	\$9,570
	Left Hand	36"	BFC8STDEC4L	\$8,360	\$9,570
6-5/8"	Right Hand	36"	BFC8STDEC6R	\$8,505	\$9,705
	Left hand	36"	BFC8STDEC6L	\$8,505	\$9,705

Available Options:

- 2 jamb widths: 4-9/16" and 6-9/16" nominal
- 1 door width: 36"
- Inswing or Outswing
- 10 Factory Pre-finished Options. Add "A" after stock number for Artisan finish
- 6 Glass Textures. See page 5. All glass textures same price
- Optional Brick Mold trim to exterior side: add \$122
- Optional ADA Threshold: add \$90
- Optional construction doors and hinges: Hollow \$750 Solid \$1,250 (set of 2)
- Optional Screens (set of 2): \$548
- Optional Hold Open arm (set of 2) \$90

CD-Series Arch Lite Double Door					
Jamb width	Active Door Handing	Doors width	Item Number	List Price Estate	List Price Artisan
4-5/8"	Right Hand	36"	BFC8STDAR4R	\$8,360	\$9,570
	Left Hand	36"	BFC8STDAR4L	\$8,360	\$9,570
6-5/8"	Right Hand	36"	BFC8STDAR6R	\$8,505	\$9,705
	Left hand	36"	BFC8STDAR6L	\$8,505	\$9,705

Available Options:

- 2 jamb widths: 4-9/16" and 6-9/16" nominal
- 1 door width: 36"
- Inswing or Outswing
- 10 Factory Pre-finished Options. Add "A" after stock number for Artisan finish
- 6 Glass Textures. See page 5. All glass textures same price
- Optional Brick Mold trim to exterior side: add \$122
- Optional ADA Threshold: add \$90
- Optional construction doors and hinges: Hollow \$750 Solid \$1,250 (set of 2)
- Optional Screens (set of 2): \$548
- Optional Hold Open arm (set of 2) \$90

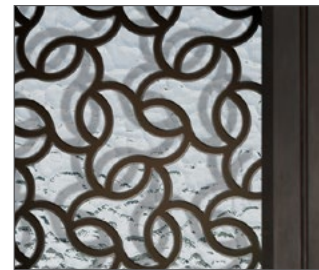
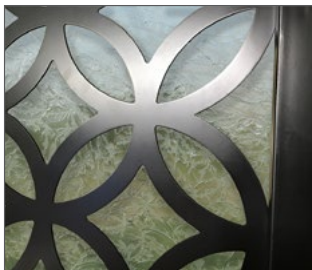

3/4 Lite Double CD-Series Entry Doors · 8'0" Tall



Minimal 3/4 Lite Double

Shown above with French Grey Satin finish and Reeds glass texture.



Cube 3/4 Lite Double

Shown above with Oil Rubbed Bronze Satin finish and clear glass texture.

CD-Series 3/4 Lite Double Door					
Jamb width	Active Door Handing	Doors width	Item Number	List Price Estate	List Price Artisan
4-5/8"	Right Hand	36"	BFC834DMN4R	\$8,235	\$9,435
	Left Hand	36"	BFC834DMN4L	\$8,235	\$9,435
6-5/8"	Right Hand	36"	BFC834DMN6R	\$8,380	\$9,580
	Left hand	36"	BFC834DMN6L	\$8,380	\$9,580

Available Options:

- 2 jamb widths: 4-9/16" and 6-9/16" nominal
- 1 door width: 36"
- Inswing or Outswing
- 10 Factory Pre-finished Options. Add "A" after stock number for Artisan finish
- 6 Glass Textures. See page 5. All glass textures same price
- Optional clavos for lower panel: 20 clavos add \$220
- Optional Brick Mold trim to exterior side: add \$122
- Optional ADA Threshold: add \$90
- Optional construction doors and hinges: Hollow \$750 Solid \$1,250 (set of 2)
- Optional Screens (set of 2): \$295
- Optional Hold Open arm (set of 2) \$90



CD-Series 3/4 Lite Double Door					
Jamb width	Active Door Handing	Doors width	Item Number	List Price Estate	List Price Artisan
4-5/8"	Right Hand	36"	BFC834DCU4R	\$8,235	\$9,435
	Left Hand	36"	BFC834DCU4L	\$8,235	\$9,435
6-5/8"	Right Hand	36"	BFC834DCU6R	\$8,380	\$9,580
	Left hand	36"	BFC834DCU6L	\$8,380	\$9,580

Available Options:

- 2 jamb widths: 4-9/16" and 6-9/16" nominal
- 1 door width: 36"
- Inswing or Outswing
- 10 Factory Pre-finished Options. Add "A" after stock number for Artisan finish
- 6 Glass Textures. See page 5. All glass textures same price
- Optional clavos for lower panel: 20 clavos add \$220
- Optional Brick Mold trim to exterior side: add \$122
- Optional ADA Threshold: add \$90
- Optional construction doors and hinges: Hollow \$750 Solid \$1,250 (set of 2)
- Optional Screens (set of 2): \$295
- Optional Hold Open arm (set of 2) \$90

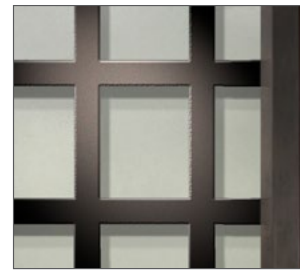

3/4 Lite Double CD-Series Entry Doors · 8'0" Tall



Arte 3/4 Lite Double

Shown above with Bronze ORB finish and Rain glass texture.



Eclectic 3/4 Lite Double

Shown above with French Grey Satin finish and Reeds glass texture.

CD-Series 3/4 Lite Double Door					
Jamb width	Active Door Handing	Doors width	Item Number	List Price Estate	List Price Artisan
4-5/8"	Right Hand	36"	BFC834DAR4R	\$8,235	\$9,435
	Left Hand	36"	BFC834DAR4L	\$8,235	\$9,435
6-5/8"	Right Hand	36"	BFC834DAR6R	\$8,380	\$9,580
	Left hand	36"	BFC834DAR6L	\$8,380	\$9,580

Available Options:

- 2 jamb widths: 4-9/16" and 6-9/16" nominal
- 1 door width: 36"
- Inswing or Outswing
- 10 Factory Pre-finished Options. Add "A" after stock number for Artisan finish
- 6 Glass Textures. See page 5. All glass textures same price
- Optional clavos for lower panel: 20 clavos add \$220
- Optional Brick Mold trim to exterior side: add \$122
- Optional ADA Threshold: add \$90
- Optional construction doors and hinges: Hollow \$750 Solid \$1,250 (set of 2)
- Optional Screens (set of 2): \$295
- Optional Hold Open arm (set of 2) \$90

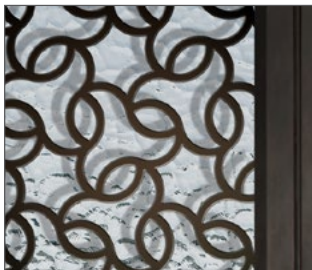

CD-Series 3/4 Lite Double Door					
Jamb width	Active Door Handing	Doors width	Item Number	List Price Estate	List Price Artisan
4-5/8"	Right Hand	36"	BFC834DEC4R	\$8,235	\$9,435
	Left Hand	36"	BFC834DEC4L	\$8,235	\$9,435
6-5/8"	Right Hand	36"	BFC834DEC6R	\$8,380	\$9,580
	Left hand	36"	BFC834DEC6L	\$8,380	\$9,580

Available Options:

- 2 jamb widths: 4-9/16" and 6-9/16" nominal
- 1 door width: 36"
- Inswing or Outswing
- 10 Factory Pre-finished Options. Add "A" after stock number for Artisan finish
- 6 Glass Textures. See page 5. All glass textures same price
- Optional clavos for lower panel: 20 clavos add \$220
- Optional Brick Mold trim to exterior side: add \$122
- Optional ADA Threshold: add \$90
- Optional construction doors and hinges: Hollow \$750 Solid \$1,250 (set of 2)
- Optional Screens (set of 2): \$295
- Optional Hold Open arm (set of 2) \$90

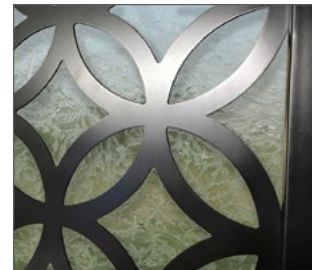

3/4 Lite Double CD-Series Entry Doors · 8'0" Tall



Contempo 3/4 Lite Double
Shown above with French Grey Satin finish
and Cloud glass texture.



Moderne 3/4 Lite Double
Shown above with Black Satin finish
and Rain glass texture.

CD-Series 3/4 Lite Double Door					
Jamb width	Active Door Handing	Doors width	Item Number	List Price Estate	List Price Artisan
4-5/8"	Right Hand	36"	BFC834DCN4R	\$8,235	\$9,435
	Left Hand	36"	BFC834DCN4L	\$8,235	\$9,435
6-5/8"	Right Hand	36"	BFC834DCN6R	\$8,380	\$9,580
	Left hand	36"	BFC834DCN6L	\$8,380	\$9,580

Available Options:

- 2 jamb widths: 4-9/16" and 6-9/16" nominal
- 1 door width: 36"
- Inswing or Outswing
- 10 Factory Pre-finished Options. Add "A" after stock number for Artisan finish
- 6 Glass Textures. See page 5. All glass textures same price
- Optional clavos for lower panel: 20 clavos add \$220
- Optional Brick Mold trim to exterior side: add \$122
- Optional ADA Threshold: add \$90
- Optional construction doors and hinges: Hollow \$750 Solid \$1,250 (set of 2)
- Optional Screens (set of 2): \$295
- Optional Hold Open arm (set of 2) \$90

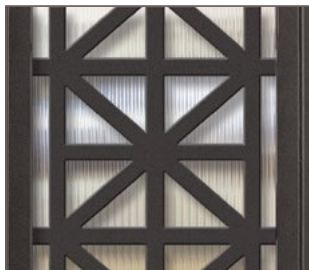

CD-Series 3/4 Lite Double Door					
Jamb width	Active Door Handing	Doors width	Item Number	List Price Estate	List Price Artisan
4-5/8"	Right Hand	36"	BFC834DMD4R	\$8,235	\$9,435
	Left Hand	36"	BFC834DMD4L	\$8,235	\$9,435
6-5/8"	Right Hand	36"	BFC834DMD6R	\$8,380	\$9,580
	Left hand	36"	BFC834DMD6L	\$8,380	\$9,580

Available Options:

- 2 jamb widths: 4-9/16" and 6-9/16" nominal
- 1 door width: 36"
- Inswing or Outswing
- 10 Factory Pre-finished Options. Add "A" after stock number for Artisan finish
- 6 Glass Textures. See page 5. All glass textures same price
- Optional clavos for lower panel: 20 clavos add \$220
- Optional Brick Mold trim to exterior side: add \$122
- Optional ADA Threshold: add \$90
- Optional construction doors and hinges: Hollow \$750 Solid \$1,250 (set of 2)
- Optional Screens (set of 2): \$295
- Optional Hold Open arm (set of 2) \$90



Full Lite Double CD-Series Entry Doors · 8'0" Tall



Urban-4 Full Lite Double

36" wide doors shown above with French Grey Satin finish and Ice Flower glass texture.



Urban-5 Full Lite Double

36" wide doors shown above with Oil Rubbed Bronze Satin finish and Ocean glass texture.

CD-Series Full Lite Double Door					
Jamb width	Active Door Handing	Doors width	Item Number	List Price Estate	List Price Artisan
4-5/8"	Right Hand	36"	BFC8FDU4L4R	\$7,740	\$8,940
	Left Hand	36"	BFC8FDU4L4L	\$7,740	\$8,940
6-5/8"	Right Hand	36"	BFC8FDU4L6R	\$7,885	\$9,085
	Left hand	36"	BFC8FDU4L6L	\$7,885	\$9,085

Available Options:

2 jamb widths: 4-9/16" and 6-9/16" nominal
 1 door width: 36"
 Inswing or Outswing
 10 Factory Pre-finished Options. Add "A" after stock number for Artisan finish
 6 Glass Textures. See page 5. All glass textures same price
 Optional Brick Mold trim to exterior side: add \$122
 Optional ADA Threshold: add \$90
 Optional construction doors and hinges: Hollow \$750 Solid \$1,250 (set of 2)
 Optional Screens (set of 2): \$377
 Optional Hold Open arm (set of 2) \$90

CD-Series Full Lite Double Door					
Jamb width	Active Door Handing	Doors width	Item Number	List Price Estate	List Price Artisan
4-5/8"	Right Hand	36"	BFC8FDU5L4R	\$7,740	\$8,940
	Left Hand	36"	BFC8FDU5L4L	\$7,740	\$8,940
6-5/8"	Right Hand	36"	BFC8FDU5L6R	\$7,885	\$9,085
	Left hand	36"	BFC8FDU5L6L	\$7,885	\$9,085

Available Options:

2 jamb widths: 4-9/16" and 6-9/16" nominal
 1 door width: 36"
 Inswing or Outswing
 10 Factory Pre-finished Options. Add "A" after stock number for Artisan finish
 6 Glass Textures. See page 5. All glass textures same price
 Optional Brick Mold trim to exterior side: add \$122
 Optional ADA Threshold: add \$90
 Optional construction doors and hinges: Hollow \$750 Solid \$1,250 (set of 2)
 Optional Screens (set of 2): \$377
 Optional Hold Open arm (set of 2) \$90

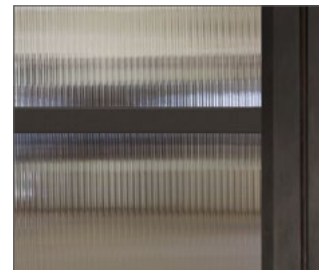

Full Lite Double CD-Series Entry Doors · 8'0" Tall



Minimal Full Lite Double

Shown above with Oil Rubbed Bronze finish and Rain glass.



Cube Full Lite Double

Shown above with French Grey Satin finish and Cloud glass texture.

CD-Series Full Lite Double Door					
Jamb width	Active Door Handing	Doors width	Item Number	List Price Estate	List Price Artisan
4-5/8"	Right Hand	36"	BFC8FDMN4R	\$7,740	\$8,940
	Left Hand	36"	BFC8FDMN4L	\$7,740	\$8,940
6-5/8"	Right Hand	36"	BFC8FDMN6R	\$7,885	\$9,085
	Left hand	36"	BFC8FDMN6L	\$7,885	\$9,085

Available Options:

- 2 jamb widths: 4-9/16" and 6-9/16" nominal
- 1 door width: 36"
- Inswing or Outswing
- 10 Factory Pre-finished Options. Add "A" after stock number for Artisan finish
- 6 Glass Textures. See page 5. All glass textures same price
- Optional Brick Mold trim to exterior side: add \$122
- Optional ADA Threshold: add \$90
- Optional construction doors and hinges: Hollow \$750 Solid \$1,250 (set of 2)
- Optional Screens (set of 2): \$377
- Optional Hold Open arm (set of 2) \$90



CD-Series Full Lite Double Door					
Jamb width	Active Door Handing	Doors width	Item Number	List Price Estate	List Price Artisan
4-5/8"	Right Hand	36"	BFC8FDCU4R	\$7,740	\$8,940
	Left Hand	36"	BFC8FDCU4L	\$7,740	\$8,940
6-5/8"	Right Hand	36"	BFC8FDCU6R	\$7,885	\$9,085
	Left hand	36"	BFC8FDCU6L	\$7,885	\$9,085

Available Options:

- 2 jamb widths: 4-9/16" and 6-9/16" nominal
- 1 door width: 36"
- Inswing or Outswing
- 10 Factory Pre-finished Options. Add "A" after stock number for Artisan finish
- 6 Glass Textures. See page 5. All glass textures same price
- Optional Brick Mold trim to exterior side: add \$122
- Optional ADA Threshold: add \$90
- Optional construction doors and hinges: Hollow \$750 Solid \$1,250 (set of 2)
- Optional Screens (set of 2): \$377
- Optional Hold Open arm (set of 2) \$90

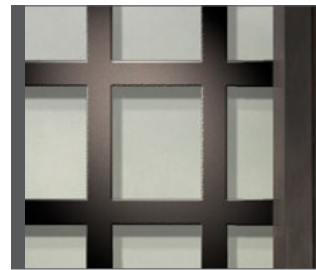

Full Lite Double CD-Series Entry Doors · 8'0" Tall



Eclectic Full Lite Double

Shown above with Satin black finish and Reeds glass.



Arte Full Lite Double

Shown above with Oil Rubbed Bronze Satin finish and Ocean glass texture.

CD-Series Full Lite Double Door					
Jamb width	Active Door Handing	Doors width	Item Number	List Price Estate	List Price Artisan
4-5/8"	Right Hand	36"	BFC8FDEC4R	\$7,740	\$8,940
	Left Hand	36"	BFC8FDEC4L	\$7,740	\$8,940
6-5/8"	Right Hand	36"	BFC8FDEC6R	\$7,885	\$9,085
	Left hand	36"	BFC8FDEC6L	\$7,885	\$9,085

Available Options:

2 jamb widths: 4-9/16" and 6-9/16" nominal
 1 door width: 36"
 Inswing or Outswing
 10 Factory Pre-finished Options. Add "A" after stock number for Artisan finish
 6 Glass Textures. See page 5. All glass textures same price
 Optional Brick Mold trim to exterior side: add \$122
 Optional ADA Threshold: add \$90
 Optional construction doors and hinges: Hollow \$750 Solid \$1,250 (set of 2)
 Optional Screens (set of 2): \$377
 Optional Hold Open arm (set of 2) \$90

CD-Series Full Lite Double Door					
Jamb width	Active Door Handing	Doors width	Item Number	List Price Estate	List Price Artisan
4-5/8"	Right Hand	36"	BFC8FDAR4R	\$7,740	\$8,940
	Left Hand	36"	BFC8FDAR4L	\$7,740	\$8,940
6-5/8"	Right Hand	36"	BFC8FDAR6R	\$7,885	\$9,085
	Left hand	36"	BFC8FDAR6L	\$7,885	\$9,085

Available Options:

2 jamb widths: 4-9/16" and 6-9/16" nominal
 1 door width: 36"
 Inswing or Outswing
 10 Factory Pre-finished Options. Add "A" after stock number for Artisan finish
 6 Glass Textures. See page 5. All glass textures same price
 Optional Brick Mold trim to exterior side: add \$122
 Optional ADA Threshold: add \$90
 Optional construction doors and hinges: Hollow \$750 Solid \$1,250 (set of 2)
 Optional Screens (set of 2): \$377
 Optional Hold Open arm (set of 2) \$90

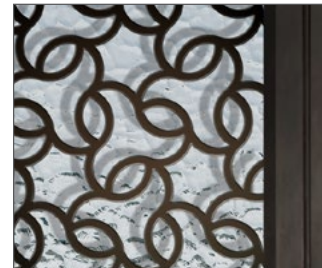
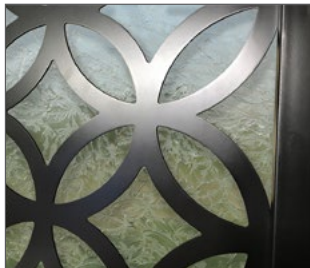

Full Lite Double CD-Series Entry Doors · 8'0" Tall



Contempo Full Lite Double

36" wide doors shown above with French Grey finish and Cloud glass.



Moderne Full Lite Double

36" wide doors shown above with Oil Rubbed Bronze Satin finish and Reeds glass texture.

CD-Series Full Lite Double Door					
Jamb width	Active Door Handing	Doors width	Item Number	List Price Estate	List Price Artisan
4-5/8"	Right Hand	36"	BFC8FDCN4R	\$7,740	\$8,940
	Left Hand	36"	BFC8FDCN4L	\$7,740	\$8,940
6-5/8"	Right Hand	36"	BFC8FDCN6R	\$7,885	\$9,085
	Left hand	36"	BFC8FDCN6L	\$7,885	\$9,085

Available Options:

- 2 jamb widths: 4-9/16" and 6-9/16" nominal
- 1 door width: 36"
- Inswing or Outswing
- 10 Factory Pre-finished Options. Add "A" after stock number for Artisan finish
- 6 Glass Textures. See page 5. All glass textures same price
- Optional Brick Mold trim to exterior side: add \$122
- Optional ADA Threshold: add \$90
- Optional construction doors and hinges: Hollow \$750 Solid \$1,250 (set of 2)
- Optional Screens (set of 2): \$377
- Optional Hold Open arm (set of 2) \$90

CD-Series Full Lite Double Door					
Jamb width	Active Door Handing	Doors width	Item Number	List Price Estate	List Price Artisan
4-5/8"	Right Hand	36"	BFC8FDMD4R	\$7,740	\$8,940
	Left Hand	36"	BFC8FDMD4L	\$7,740	\$8,940
6-5/8"	Right Hand	36"	BFC8FDMD6R	\$7,885	\$9,085
	Left hand	36"	BFC8FDMD6L	\$7,885	\$9,085

Available Options:

- 2 jamb widths: 4-9/16" and 6-9/16" nominal
- 1 door width: 36"
- Inswing or Outswing
- 10 Factory Pre-finished Options. Add "A" after stock number for Artisan finish
- 6 Glass Textures. See page 5. All glass textures same price
- Optional Brick Mold trim to exterior side: add \$122
- Optional ADA Threshold: add \$90
- Optional construction doors and hinges: Hollow \$750 Solid \$1,250 (set of 2)
- Optional Screens (set of 2): \$377
- Optional Hold Open arm (set of 2) \$90

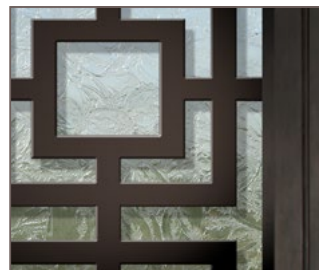
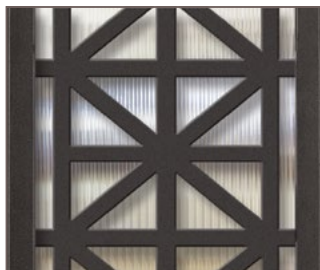

3/4 Lite Single CD-Series Entry Doors · 8'0" Tall x 36"/42"



Urban-4 3/4 Lite Single

Shown above with French Grey satin finish and clear glass texture.



Urban-5 3/4 Lite Single

Shown above with French Grey finish and Reeds glass texture.

CD-Series 3/4 Lite Single Door					
Jamb width	Active Door Handing	Doors width	Item Number	List Price Estate	List Price Artisan
4-5/8"	Right Hand	36"	BFC834U4L4R	\$4,365	\$4,965
		42"	BFC8434U4L4R	\$4,725	\$5,325
	Left Hand	36"	BFC834U4L4L	\$4,365	\$4,965
		42"	BFC8434U4L4L	\$4,725	\$5,325
6-5/8"	Right Hand	36"	BFC834U4L6R	\$4,495	\$5,095
		42"	BFC8434U4L6R	\$4,875	\$5,475
	Left hand	36"	BFC834U4L6L	\$4,495	\$5,095
		42"	BFC8434U4L6L	\$4,875	\$5,475

Available Options:

2 jamb widths: 4-9/16" and 6-9/16" nominal Inswing or Outswing
 2 door widths: 36" or 42"
 10 Factory Pre-finished Options. Add "A" after stock number for Artisan finish
 6 Glass Textures. See page 5. All glass textures same price
 Optional clavos for lower panel: 10 clavos add \$110
 Optional Brick Mold trim to exterior side: Add \$104 for 36" door, \$122 for 42" door
 Optional ADA Threshold: add \$45
 Optional Screen: add \$148
 Optional Hold Open Arm: add \$45
 Optional Strike Jamb Reinforcement: add \$90

CD-Series 3/4 Lite Single Door					
Jamb width	Active Door Handing	Doors width	Item Number	List Price Estate	List Price Artisan
4-5/8"	Right Hand	36"	BFC834U5L4R	\$4,365	\$4,965
		42"	BFC8434U5L4R	\$4,725	\$5,325
	Left Hand	36"	BFC834U5L4L	\$4,365	\$4,965
		42"	BFC8434U5L4L	\$4,725	\$5,325
6-5/8"	Right Hand	36"	BFC834U5L6R	\$4,495	\$5,095
		42"	BFC8434U5L6R	\$4,875	\$5,475
	Left hand	36"	BFC834U5L6L	\$4,495	\$5,095
		42"	BFC8434U5L6L	\$4,875	\$5,475

Available Options:

2 jamb widths: 4-9/16" and 6-9/16" nominal Inswing or Outswing
 2 door widths: 36" or 42"
 10 Factory Pre-finished Options. Add "A" after stock number for Artisan finish
 6 Glass Textures. See page 5. All glass textures same price
 Optional clavos for lower panel: 10 clavos add \$110
 Optional Brick Mold trim to exterior side: Add \$104 for 36" door, \$122 for 42" door
 Optional ADA Threshold: add \$45
 Optional Screen: add \$148
 Optional Hold Open Arm: add \$45
 Optional Strike Jamb Reinforcement: add \$90

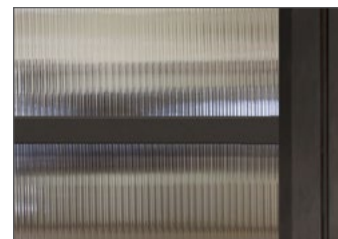

See page 16-17 for detailed size specifications and handing description.

3/4 Lite Single CD-Series Entry Doors · 8'0" Tall x 36"/42"



Minimal 3/4 Lite Single

Shown above with Black Satin finish and Rain glass texture.



Cube 3/4 Lite Single

Shown above with Oil Rubbed Bronze finish and Cloud glass texture. Optional clavos shown.

CD-Series 3/4 Lite Single Door					
Jamb width	Active Door Handing	Doors width	Item Number	List Price Estate	List Price Artisan
4-5/8"	Right Hand	36"	BFC834MN4R	\$4,365	\$4,965
		42"	BFC8434MN4R	\$4,725	\$5,325
	Left Hand	36"	BFC834MN4L	\$4,365	\$4,965
		42"	BFC8434MN4L	\$4,725	\$5,325
6-5/8"	Right Hand	36"	BFC834MN6R	\$4,495	\$5,095
		42"	BFC8434MN6R	\$4,875	\$5,475
	Left hand	36"	BFC834MN6L	\$4,495	\$5,095
		42"	BFC8434MN6L	\$4,875	\$5,475

CD-Series 3/4 Lite Single Door					
Jamb width	Active Door Handing	Doors width	Item Number	List Price Estate	List Price Artisan
4-5/8"	Right Hand	36"	BFC834CU4R	\$4,365	\$4,965
		42"	BFC8434CU4R	\$4,725	\$5,325
	Left Hand	36"	BFC834CU4L	\$4,365	\$4,965
		42"	BFC8434CU4L	\$4,725	\$5,325
6-5/8"	Right Hand	36"	BFC834CU6R	\$4,495	\$5,095
		42"	BFC8434CU6R	\$4,875	\$5,475
	Left hand	36"	BFC834CU6L	\$4,495	\$5,095
		42"	BFC8434CU6L	\$4,875	\$5,475

Available Options:

2 jamb widths: 4-9/16" and 6-9/16" nominal Inswing or Outswing
 2 door widths: 36" or 42"
 10 Factory Pre-finished Options. Add "A" after stock number for Artisan finish
 6 Glass Textures. See page 5. All glass textures same price
 Optional clavos for lower panel: 10 clavos add \$110
 Optional Brick Mold trim to exterior side: Add \$104 for 36" door, \$122 for 42" door
 Optional ADA Threshold: add \$45
 Optional Screen: add \$148
 Optional Hold Open Arm: add \$45
 Optional Strike Jamb Reinforcement: add \$90

Available Options:

2 jamb widths: 4-9/16" and 6-9/16" nominal Inswing or Outswing
 2 door widths: 36" or 42"
 10 Factory Pre-finished Options. Add "A" after stock number for Artisan finish
 6 Glass Textures. See page 5. All glass textures same price
 Optional clavos for lower panel: 10 clavos add \$110
 Optional Brick Mold trim to exterior side: Add \$104 for 36" door, \$122 for 42" door
 Optional ADA Threshold: add \$45
 Optional Screen: add \$148
 Optional Hold Open Arm: add \$45
 Optional Strike Jamb Reinforcement: add \$90

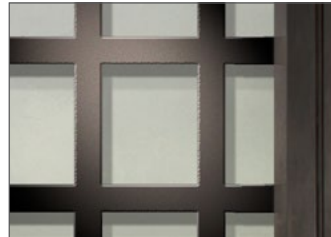

3/4 Lite Single CD-Series Entry Doors · 8'0" Tall x 36 / 42"



Arte 3/4 Lite Single
Shown above with French Grey Satin finish and Clear glass.



Eclectic 3/4 Lite Single
Shown above with Black Satin finish and Cloud glass texture.

CD-Series 3/4 Lite Single Door					
Jamb width	Active Door Handing	Doors width	Item Number	List Price Estate	List Price Artisan
4-5/8"	Right Hand	36"	BFC834AR4R	\$4,365	\$4,965
		42"	BFC8434AR4R	\$4,725	\$5,325
	Left Hand	36"	BFC834AR4L	\$4,365	\$4,965
		42"	BFC8434AR4L	\$4,725	\$5,325
6-5/8"	Right Hand	36"	BFC834AR6R	\$4,495	\$5,095
		42"	BFC8434AR6R	\$4,875	\$5,475
	Left hand	36"	BFC834AR6L	\$4,495	\$5,095
		42"	BFC8434AR6L	\$4,875	\$5,475

Available Options:

2 jamb widths: 4-9/16" and 6-9/16" nominal Inswing or Outswing
 2 door widths: 36" or 42"
 10 Factory Pre-finished Options. Add "A" after stock number for Artisan finish
 6 Glass Textures. See page 5. All glass textures same price
 Optional clavos for lower panel: 10 clavos add \$110
 Optional Brick Mold trim to exterior side: Add \$104 for 36" door, \$122 for 42" door
 Optional ADA Threshold: add \$45
 Optional Screen: add \$148
 Optional Hold Open Arm: add \$45
 Optional Strike Jamb Reinforcement: add \$90

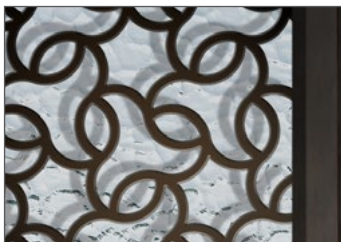

CD-Series 3/4 Lite Single Door					
Jamb width	Active Door Handing	Doors width	Item Number	List Price Estate	List Price Artisan
4-5/8"	Right Hand	36"	BFC834EC4R	\$4,365	\$4,965
		42"	BFC8434EC4R	\$4,725	\$5,325
	Left Hand	36"	BFC834EC4L	\$4,365	\$4,965
		42"	BFC8434EC4L	\$4,725	\$5,325
6-5/8"	Right Hand	36"	BFC834EC6R	\$4,495	\$5,095
		42"	BFC8434EC6R	\$4,875	\$5,475
	Left hand	36"	BFC834EC6L	\$4,495	\$5,095
		42"	BFC8434EC6L	\$4,875	\$5,475

Available Options:

2 jamb widths: 4-9/16" and 6-9/16" nominal Inswing or Outswing
 2 door widths: 36" or 42"
 10 Factory Pre-finished Options. Add "A" after stock number for Artisan finish
 6 Glass Textures. See page 5. All glass textures same price
 Optional clavos for lower panel: 10 clavos add \$110
 Optional Brick Mold trim to exterior side: Add \$104 for 36" door, \$122 for 42" door
 Optional ADA Threshold: add \$45
 Optional Screen: add \$148
 Optional Hold Open Arm: add \$45
 Optional Strike Jamb Reinforcement: add \$90



See page 16-17 for detailed size specifications and handing description.

3/4 Lite Single CD-Series Entry Doors · 8'0" Tall x 36"/42"



Contempo 3/4 Lite Single
Shown above with Black Satin finish and Rain glass texture.



Moderne 3/4 Lite Single
Shown above with Oil Rubbed Bronze Satin finish and Cloud glass texture.

CD-Series 3/4 Lite Single Door					
Jamb width	Active Door Handing	Doors width	Item Number	List Price Estate	List Price Artisan
4-5/8"	Right Hand	36"	BFC834CN4R	\$4,365	\$4,965
		42"	BFC8434CN4R	\$4,725	\$5,325
	Left Hand	36"	BFC834CN4L	\$4,365	\$4,965
		42"	BFC8434CN4L	\$4,725	\$5,325
6-5/8"	Right Hand	36"	BFC834CN6R	\$4,495	\$5,095
		42"	BFC8434CN6R	\$4,875	\$5,475
	Left hand	36"	BFC834CN6L	\$4,495	\$5,095
		42"	BFC8434CN6L	\$4,875	\$5,475

CD-Series 3/4 Lite Single Door					
Jamb width	Active Door Handing	Doors width	Item Number	List Price Estate	List Price Artisan
4-5/8"	Right Hand	36"	BFC834MD4R	\$4,365	\$4,965
		42"	BFC8434MD4R	\$4,725	\$5,325
	Left Hand	36"	BFC834MD4L	\$4,365	\$4,965
		42"	BFC8434MD4L	\$4,725	\$5,325
6-5/8"	Right Hand	36"	BFC834MD6R	\$4,495	\$5,095
		42"	BFC8434MD6R	\$4,875	\$5,475
	Left hand	36"	BFC834MD6L	\$4,495	\$5,095
		42"	BFC8434MD6L	\$4,875	\$5,475

Available Options:
 2 jamb widths: 4-9/16" and 6-9/16" nominal Inswing or Outswing
 2 door widths: 36" or 42"
 10 Factory Pre-finished Options. Add "A" after stock number for Artisan finish
 6 Glass Textures. See page 5. All glass textures same price
 Optional clavos for lower panel: 10 clavos add \$110
 Optional Brick Mold trim to exterior side: Add \$104 for 36" door, \$122 for 42" door
 Optional ADA Threshold: add \$45
 Optional Screen: add \$148
 Optional Hold Open Arm: add \$45
 Optional Strike Jamb Reinforcement: add \$90

Available Options:
 2 jamb widths: 4-9/16" and 6-9/16" nominal Inswing or Outswing
 2 door widths: 36" or 42"
 10 Factory Pre-finished Options. Add "A" after stock number for Artisan finish
 6 Glass Textures. See page 5. All glass textures same price
 Optional clavos for lower panel: 10 clavos add \$110
 Optional Brick Mold trim to exterior side: Add \$104 for 36" door, \$122 for 42" door
 Optional ADA Threshold: add \$45
 Optional Screen: add \$148
 Optional Hold Open Arm: add \$45
 Optional Strike Jamb Reinforcement: add \$90

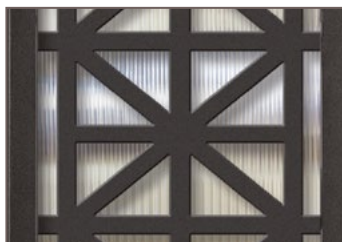

Full Lite Single CD-Series Entry Doors · 8'0" Tall x 36"/42"



Urban-4 Full Lite Single

36" wide door shown above with Black Satin finish and Rain glass texture.



Urban-5 Full Lite Single

36" wide door shown above with Black Satin finish and Cloud glass texture.

CD-Series Full Lite Single Door					
Jamb width	Active Door Handing	Doors width	Item Number	List Price Estate	List Price Artisan
4-5/8"	Right Hand	36"	BFC8U4L4R	\$4,050	\$4,650
		42"	BFC8U4L4R	\$4,455	\$5,055
	Left Hand	36"	BFC8U4L4L	\$4,050	\$4,650
		42"	BFC8U4L4L	\$4,455	\$5,055
6-5/8"	Right Hand	36"	BFC8U4L6R	\$4,180	\$4,780
		42"	BFC8U4L6R	\$4,605	\$5,205
	Left hand	36"	BFC8U4L6L	\$4,180	\$4,780
		42"	BFC8U4L6L	\$4,605	\$5,205

Available Options:

2 jamb widths: 4-9/16" and 6-9/16" nominal
 2 door widths: 36" or 42"
 Inswing or Outswing
 10 Factory Pre-finished Options. Add "A" after stock number for Artisan finish
 6 Glass Textures. See page 5. All glass textures same price
 Optional Brick Mold trim to exterior side: Add \$104 for 36" door, \$122 for 42" door
 Optional ADA Threshold: add \$45
 Optional Screen: \$189
 Optional Hold Open Arms: \$45

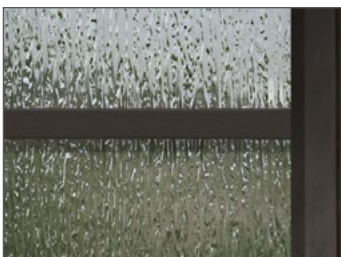

CD-Series Full Lite Single Door					
Jamb width	Active Door Handing	Doors width	Item Number	List Price Estate	List Price Artisan
4-5/8"	Right Hand	36"	BFC8U5L4R	\$4,050	\$4,650
		42"	BFC8U5L4R	\$4,455	\$5,055
	Left Hand	36"	BFC8U5L4L	\$4,050	\$4,650
		42"	BFC8U5L4L	\$4,455	\$5,055
6-5/8"	Right Hand	36"	BFC8U5L6R	\$4,180	\$4,780
		42"	BFC8U5L6R	\$4,605	\$5,205
	Left hand	36"	BFC8U5L6L	\$4,180	\$4,780
		42"	BFC8U5L6L	\$4,605	\$5,205

Available Options:

2 jamb widths: 4-9/16" and 6-9/16" nominal
 2 door widths: 36" or 42"
 Inswing or Outswing
 10 Factory Pre-finished Options. Add "A" after stock number for Artisan finish
 6 Glass Textures. See page 5. All glass textures same price
 Optional Brick Mold trim to exterior side: Add \$104 for 36" door, \$122 for 42" door
 Optional ADA Threshold: add \$45
 Optional Screen: \$189
 Optional Hold Open Arms: \$45

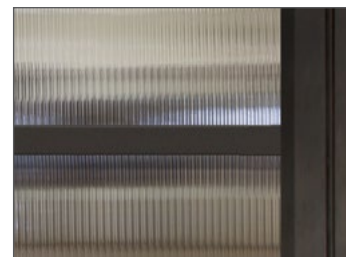

Full Lite Single CD-Series Entry Doors · 8'0" Tall x 36"/42"



Minimal Full Lite Single

Shown above with Black Satin finish and Ice Flower glass texture.



Cube Full Lite Single

Shown above with Black Satin finish and Rain glass texture.

CD-Series Full Lite Single Door					
Jamb width	Active Door Handing	Doors width	Item Number	List Price Estate	List Price Artisan
4-5/8"	Right Hand	36"	BFC8MN4R	\$4,050	\$4,650
		42"	BFC84MN4R	\$4,455	\$5,055
	Left Hand	36"	BFC8MN4L	\$4,050	\$4,650
		42"	BFC84MN4L	\$4,455	\$5,055
6-5/8"	Right Hand	36"	BFC8MN6R	\$4,180	\$4,780
		42"	BFC84MN6R	\$4,605	\$5,205
	Left hand	36"	BFC8MN6L	\$4,180	\$4,780
		42"	BFC84MN6L	\$4,605	\$5,205

Available Options:

- 2 jamb widths: 4-9/16" and 6-9/16" nominal
- 2 door widths: 36" or 42"
- Inswing or Outswing
- 10 Factory Pre-finished Options. Add "A" after stock number for Artisan finish
- 6 Glass Textures. See page 5. All glass textures same price
- Optional Brick Mold trim to exterior side: Add \$104 for 36" door, \$122 for 42" door
- Optional ADA Threshold: add \$45
- Optional Screen: \$189
- Optional Hold Open Arms: \$45

CD-Series Full Lite Single Door					
Jamb width	Active Door Handing	Doors width	Item Number	List Price Estate	List Price Artisan
4-5/8"	Right Hand	36"	BFC8CU4R	\$4,050	\$4,650
		42"	BFC84CU4R	\$4,455	\$5,055
	Left Hand	36"	BFC8CU4L	\$4,050	\$4,650
		42"	BFC84CU4L	\$4,455	\$5,055
6-5/8"	Right Hand	36"	BFC8CU6R	\$4,180	\$4,780
		42"	BFC84CU6R	\$4,605	\$5,205
	Left hand	36"	BFC8CU6L	\$4,180	\$4,780
		42"	BFC84CU6L	\$4,605	\$5,205

Available Options:

- 2 jamb widths: 4-9/16" and 6-9/16" nominal
- 2 door widths: 36" or 42"
- Inswing or Outswing
- 10 Factory Pre-finished Options. Add "A" after stock number for Artisan finish
- 6 Glass Textures. See page 5. All glass textures same price
- Optional Brick Mold trim to exterior side: Add \$104 for 36" door, \$122 for 42" door
- Optional ADA Threshold: add \$45
- Optional Screen: \$189
- Optional Hold Open Arms: \$45



Full Lite Single CD-Series Entry Doors · 8'0" Tall x 36 / 42"



Arte Full Lite Single
Shown above with Black Satin finish and Rain glass texture.



Eclectic Full Lite Single
Shown above with French Grey finish and Ice Flower glass texture.

CD-Series Full Lite Single Door					
Jamb width	Active Door Handing	Doors width	Item Number	List Price Estate	List Price Artisan
4-5/8"	Right Hand	36"	BFC8AR4R	\$4,050	\$4,650
		42"	BFC84AR4R	\$4,455	\$5,055
	Left Hand	36"	BFC8AR4L	\$4,050	\$4,650
		42"	BFC84AR4L	\$4,455	\$5,055
6-5/8"	Right Hand	36"	BFC8AR6R	\$4,180	\$4,780
		42"	BFC84AR6R	\$4,605	\$5,205
	Left hand	36"	BFC8AR6L	\$4,180	\$4,780
		42"	BFC84AR6L	\$4,605	\$5,205

Available Options:
 2 jamb widths: 4-9/16" and 6-9/16" nominal
 2 door widths: 36" or 42"
 Inswing or Outswing
 10 Factory Pre-finished Options. Add "A" after stock number for Artisan finish
 6 Glass Textures. See page 5. All glass textures same price
 Optional Brick Mold trim to exterior side: Add \$104 for 36" door, \$122 for 42" door
 Optional ADA Threshold: add \$45
 Optional Screen: \$189
 Optional Hold Open Arms: \$45

CD-Series Full Lite Single Door					
Jamb width	Active Door Handing	Doors width	Item Number	List Price Estate	List Price Artisan
4-5/8"	Right Hand	36"	BFC8EC4R	\$4,050	\$4,650
		42"	BFC84EC4R	\$4,455	\$5,055
	Left Hand	36"	BFC8EC4L	\$4,050	\$4,650
		42"	BFC84EC4L	\$4,455	\$5,055
6-5/8"	Right Hand	36"	BFC8EC6R	\$4,180	\$4,780
		42"	BFC84EC6R	\$4,605	\$5,205
	Left hand	36"	BFC8EC6L	\$4,180	\$4,780
		42"	BFC84EC6L	\$4,605	\$5,205

Available Options:
 2 jamb widths: 4-9/16" and 6-9/16" nominal
 2 door widths: 36" or 42"
 Inswing or Outswing
 10 Factory Pre-finished Options. Add "A" after stock number for Artisan finish
 6 Glass Textures. See page 5. All glass textures same price
 Optional Brick Mold trim to exterior side: Add \$104 for 36" door, \$122 for 42" door
 Optional ADA Threshold: add \$45
 Optional Screen: \$189
 Optional Hold Open Arms: \$45

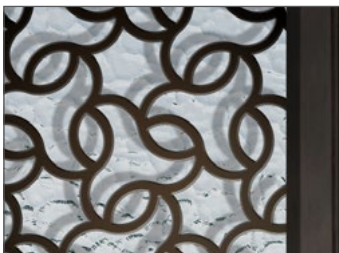

Full Lite Single CD-Series Entry Doors · 8'0" Tall x 36"/42"



Contempo Full Lite Single

Shown above with Black Satin finish and Rain glass texture.



Moderne Full Lite Single

Shown above with French Grey finish and Reeds glass texture.

CD-Series Full Lite Single Door					
Jamb width	Active Door Handing	Doors width	Item Number	List Price Estate	List Price Artisan
4-5/8"	Right Hand	36"	BFC8CN4R	\$4,050	\$4,650
		42"	BFC84CN4R	\$4,455	\$5,055
	Left Hand	36"	BFC8CN4L	\$4,050	\$4,650
		42"	BFC84CN4L	\$4,455	\$5,055
6-5/8"	Right Hand	36"	BFC8CN6R	\$4,180	\$4,780
		42"	BFC84CN6R	\$4,605	\$5,205
	Left hand	36"	BFC8CN6L	\$4,180	\$4,780
		42"	BFC84CN6L	\$4,605	\$5,205

CD-Series Full Lite Single Door					
Jamb width	Active Door Handing	Doors width	Item Number	List Price Estate	List Price Artisan
4-5/8"	Right Hand	36"	BFC8MD4R	\$4,050	\$4,650
		42"	BFC84MD4R	\$4,455	\$5,055
	Left Hand	36"	BFC8MD4L	\$4,050	\$4,650
		42"	BFC84MD4L	\$4,455	\$5,055
6-5/8"	Right Hand	36"	BFC8MD6R	\$4,180	\$4,780
		42"	BFC84MD6R	\$4,605	\$5,205
	Left hand	36"	BFC8MD6L	\$4,180	\$4,780
		42"	BFC84MD6L	\$4,605	\$5,205

Available Options:

2 jamb widths: 4-9/16" and 6-9/16" nominal
 2 door widths: 36" or 42"
 Inswing or Outswing
 10 Factory Pre-finished Options. Add "A" after stock number for Artisan finish
 6 Glass Textures. See page 5. All glass textures same price
 Optional Brick Mold trim to exterior side: Add \$104 for 36" door, \$122 for 42" door
 Optional ADA Threshold: add \$45
 Optional Screen: \$189
 Optional Hold Open Arms: \$45

Available Options:

2 jamb widths: 4-9/16" and 6-9/16" nominal
 2 door widths: 36" or 42"
 Inswing or Outswing
 10 Factory Pre-finished Options. Add "A" after stock number for Artisan finish
 6 Glass Textures. See page 5. All glass textures same price
 Optional Brick Mold trim to exterior side: Add \$104 for 36" door, \$122 for 42" door
 Optional ADA Threshold: add \$45
 Optional Screen: \$189
 Optional Hold Open Arms: \$45

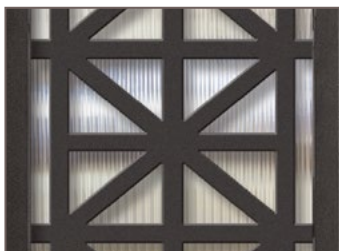



Privacy Glass PG-Series Doors

The PG Series in the Buffalo Forge ThermaPremium line features high-quality 14 gauge thick steel doors with 6 glass textures and 15 beautiful finish options. Premium in appearance and details, these steel doors are thermally broken to prevent the transfer of heat and cold from the exterior to the interior, so your home can stay warm and comfortable even during extreme summer or winter. Perfect for patios or entryways. Complement these doors with our 2-point or multi-point handlesets.

Photo: Full lite square top double doors with reeds glass and Lumina handleset.

PG-SERIES PRIVACY GLASS DOORS

8'0" BUFFALO FORGE THERMAPREMIUM STEEL ENTRY DOORS

PG-SERIES 8'0" TALL BUFFALO FORGE STEEL DOORS



Glass Texture Options:



Unique features of GlassCraft's PG-Series

- The Buffalo Forge ThermaPremium PG-Series doors are designed with a unique face-mounted frame system that gives the look of a raised-moulding detail and provides greater architectural definition.
- As with all doors in this catalog, the PG series features a multi-patented thermally-broken door to provide maximum efficiency and to eliminate frost on the interior side of the door during cold weather.
- Each unit is pre-assembled and installed into a test wall to ensure hassle-free onsite installation.
- Optional removeable screens are available for all doors
- Glass Panels are operable from the inside. When these glass panels are open, there is no protective metal grill between the inside and outside.
- Six different glass textures are available
- Several handlesets are available or use your own door hardware.
- Fifteen different finish colors are available
- Unique cast bronze and heavy-duty hinges for long-lasting use
- Endura brand solid composite thresholds may be adjusted to ensure a weatherproof seal. Other brands use cheap hollow sills that can dent and are not adjustable.
- Double Insulated glass panels that are energy efficient and thermally insulating.



WINDSTORM RATED and Certified PG-Series Doors

All PG-Series entryway designs have been certified by an independent laboratory to be windstorm approved. Please refer to our website for specific DP Ratings or design pressure certifications for each Buffalo Forge entry door configuration.

Entryway Configurations

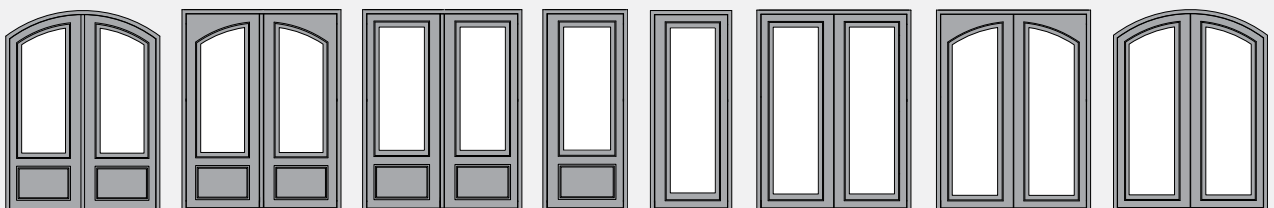

3/4 Lite Arch Double Glass Entry Doors · 8'0" Tall



Privacy Glass 3/4 Arch Top Double

Shown above with French Grey Satin finish and Reeds glass texture. Optional round clavos shown.



Privacy Glass 3/4 Arch Lite Double

Shown above with Oil Rubbed Bronze Satin finish and Cloud glass texture.

PG-Series 3/4 Arch Top Double Door					
Jamb width	Active Door Handing	Doors width	Item Number	List Price Estate	List Price Artisan
4-5/8"	Right Hand	36"	BFP834ATD4R	\$7,750	\$8,950
	Left Hand	36"	BFP834ATD4L	\$7,750	\$8,950
6-5/8"	Right Hand	36"	BFP834ATD6R	\$8,035	\$9,235
	Left hand	36"	BFP834ATD6L	\$8,035	\$9,235

Available Options:

- 2 jamb widths: 4-9/16" and 6-9/16" nominal
- 1 door width: 36"
- Inswing or Outswing
- 10 Factory Pre-finished Options. Add "A" after stock number for Artisan finish
- 6 Glass Textures. See page 5. All glass textures same price
- Multi-Point hardware options: see page 15
- Optional Brick Mold trim to exterior side: add \$336
- Optional ADA Threshold: add \$90
- Optional clavos for lower panel: 20 clavos add \$220
- Optional construction doors and hinges: Hollow \$750 Solid \$1,250 (set of 2)
- Optional Screens (set of 2): \$466
- Optional Hold Open arm (set of 2) \$90

PG-Series 3/4 Arch Lite Double Door					
Jamb width	Active Door Handing	Doors width	Item Number	List Price Estate	List Price Artisan
4-5/8"	Right Hand	36"	BFP834STD4R	\$7,650	\$8,850
	Left Hand	36"	BFP834STD4L	\$7,650	\$8,850
6-5/8"	Right Hand	36"	BFP834STD6R	\$7,795	\$8,995
	Left hand	36"	BFP834STD6L	\$7,795	\$8,995

Available Options:

- 2 jamb widths: 4-9/16" and 6-9/16" nominal
- 1 door width: 36"
- Inswing or Outswing
- 10 Factory Pre-finished Options. Add "A" after stock number for Artisan finish
- 6 Glass Textures. See page 5. All glass textures same price
- Multi-Point hardware options: see page 15
- Optional Brick Mold trim to exterior side: add \$122
- Optional ADA Threshold: add \$90
- Optional clavos for lower panel: 20 clavos add \$220
- Optional construction doors and hinges: Hollow \$750 Solid \$1,250 (set of 2)
- Optional Screens (set of 2): \$466
- Optional Hold Open arm (set of 2) \$90

Full Lite Arch Double Glass Entry Doors · 8'0" Tall



Privacy Glass Arch Top Double

Shown above with Medium Bronze Satin finish and Ocean glass texture.



Privacy Glass Arch Lite Double

Shown above with Black Satin finish and Rain glass texture.

PG-Series Arch Top Double Door					
Jamb width	Active Door Handing	Doors width	Item Number	List Price Estate	List Price Artisan
4-5/8"	Right Hand	36"	BFP8ATD4R	\$7,450	\$8,650
	Left Hand	36"	BFP8ATD4L	\$7,450	\$8,650
6-5/8"	Right Hand	36"	BFP8ATD6R	\$7,735	\$8,935
	Left hand	36"	BFP8ATD6L	\$7,735	\$8,935

Available Options:

- 2 jamb widths: 4-9/16" and 6-9/16" nominal
- 1 door width: 36"
- Inswing or Outswing
- 10 Factory Pre-finished Options. Add "A" after stock number for Artisan finish
- 6 Glass Textures. See page 5. All glass textures same price
- Multi-Point hardware options: see page 15
- Optional Brick Mold trim to exterior side: add \$336
- Optional ADA Threshold: add \$90
- Optional construction doors and hinges: Hollow \$750 Solid \$1,250 (set of 2)
- Optional Screens (set of 2): \$548
- Optional Hold Open arm (set of 2) \$90

PG-Series Arch Lite Double Door					
Jamb width	Active Door Handing	Doors width	Item Number	List Price Estate	List Price Artisan
4-5/8"	Right Hand	36"	BFP8STD4R	\$7,350	\$8,550
	Left Hand	36"	BFP8STD4L	\$7,350	\$8,550
6-5/8"	Right Hand	36"	BFP8STD6R	\$7,495	\$8,695
	Left hand	36"	BFP8STD6L	\$7,495	\$8,695

Available Options:

- 2 jamb widths: 4-9/16" and 6-9/16" nominal
- 1 door width: 36"
- Inswing or Outswing
- 10 Factory Pre-finished Options. Add "A" after stock number for Artisan finish
- 6 Glass Textures. See page 5. All glass textures same price
- Multi-Point hardware options: see page 15
- Optional Brick Mold trim to exterior side: add \$122
- Optional ADA Threshold: add \$90
- Optional construction doors and hinges: Hollow \$750 Solid \$1,250 (set of 2)
- Optional Screens (set of 2): \$548
- Optional Hold Open arm (set of 2) \$90

Double Glass Entry Doors · 8'0" Tall



Glass 3/4 Lite Double

Shown above with French Grey Satin finish and Reeds glass texture.



Glass Full Lite Double

Shown above with Oil Rubbed Bronze Satin finish and Rain glass texture.

PG-Series 3/4 Lite Double Door					
Jamb width	Active Door Handing	Doors width	Item Number	List Price Estate	List Price Artisan
4-5/8"	Right Hand	36"	BFP834D4R	\$7,065	\$8,265
	Left Hand	36"	BFP834D4L	\$7,065	\$8,265
6-5/8"	Right Hand	36"	BFP834D6R	\$7,210	\$8,410
	Left hand	36"	BFP834D6L	\$7,210	\$8,410

PG-Series Full Lite Double Door					
Jamb width	Active Door Handing	Doors width	Item Number	List Price Estate	List Price Artisan
4-5/8"	Right Hand	36"	BFP8FD4R	\$6,800	\$8,000
	Left Hand	36"	BFP8FD4L	\$6,800	\$8,000
6-5/8"	Right Hand	36"	BFP8FD6R	\$6,945	\$8,145
	Left hand	36"	BFP8FD6L	\$6,945	\$8,145

Available Options:

- 2 jamb widths: 4-9/16" and 6-9/16" nominal
- 1 door width: 36"
- Inswing or Outswing
- 10 Factory Pre-finished Options. Add "A" after stock number for Artisan finish
- 6 Glass Textures. See page 5. All glass textures same price
- Multi-Point hardware options: see page 15
- Optional Decorative Clavos for lower panel: 20 clavos add \$220
- Optional Brick Mold trim to exterior side: add \$122
- Optional ADA Threshold: add \$90
- Optional construction doors and hinges: Hollow \$750 Solid \$1,250 (set of 2)
- Optional Screens (set of 2): \$295
- Optional Hold Open arm (set of 2) \$90

Available Options:

- 2 jamb widths: 4-9/16" and 6-9/16" nominal
- 1 door width: 36"
- Inswing or Outswing
- 10 Factory Pre-finished Options. Add "A" after stock number for Artisan finish
- 6 Glass Textures. See page 5. All glass textures same price
- Multi-Point hardware options: see page 15
- Optional Brick Mold trim to exterior side: add \$122
- Optional ADA Threshold: add \$90
- Optional construction doors and hinges: Hollow \$750 Solid \$1,250 (set of 2)
- Optional Screens (set of 2): \$377
- Optional Hold Open arm (set of 2) \$90

Single Glass Entry Doors · 8'0" Tall x 36" / 42"



Glass 3/4 Lite Single

Shown above with French Grey Satin finish and Clear glass.



Glass Full Lite Single

Shown above with French Grey Satin finish and Ice Flower glass texture.

PG-Series 3/4 Lite Single Door					
Jamb width	Active Door Handing	Doors width	Item Number	List Price Estate	List Price Artisan
4-5/8"	Right Hand	36"	BFP8344R	\$3,925	\$4,525
		42"	BFP84344R	\$4,150	\$4,750
	Left Hand	36"	BFP8344L	\$3,925	\$4,525
		42"	BFP84344L	\$4,150	\$4,750
6-5/8"	Right Hand	36"	BFP8346R	\$4,055	\$4,655
		42"	BFP84346R	\$4,300	\$4,900
	Left hand	36"	BFP8346L	\$4,055	\$4,655
		42"	BFP84346L	\$4,300	\$4,900

Available Options:

- 2 jamb widths: 4-9/16" and 6-9/16" nominal Inswing or Outswing
- 2 door widths: 36" or 42"
- 10 Factory Pre-finished Options. Add "A" after stock number for Artisan finish
- 6 Glass Textures. See page 5. All glass textures same price
- Multi-Point hardware options: see page 15
- Optional clavos for lower panel: 10 clavos add \$110
- Optional Brick Mold trim to exterior side: Add \$104 for 36" door, \$122 for 42" door
- Optional ADA Threshold: add \$45
- Optional Screen: add \$148
- Optional Hold Open Arm: add \$45
- Optional Strike Jamb Reinforcement: add \$90

PG-Series Full Lite Single Door					
Jamb width	Active Door Handing	Doors width	Item Number	List Price Estate	List Price Artisan
4-5/8"	Right Hand	36"	BFP84R	\$3,600	\$4,200
		42"	BFP844R	\$3,875	\$4,475
	Left Hand	36"	BFP84L	\$3,600	\$4,200
		42"	BFP844L	\$3,875	\$4,475
6-5/8"	Right Hand	36"	BFP86R	\$3,730	\$4,330
		42"	BFP846R	\$4,025	\$4,625
	Left hand	36"	BFP86L	\$3,730	\$4,330
		42"	BFP846L	\$4,025	\$4,625

Available Options:

- 2 jamb widths: 4-9/16" and 6-9/16" nominal Inswing or Outswing
- 2 door widths: 36" or 42"
- 10 Factory Pre-finished Options. Add "A" after stock number for Artisan finish
- 6 Glass Textures. See page 5. All glass textures same price
- Multi-Point hardware options: see page 15
- Optional clavos for lower panel: 10 clavos add \$110
- Optional Brick Mold trim to exterior side: Add \$104 for 36" door, \$122 for 42" door
- Optional ADA Threshold: add \$45
- Optional Screen: add \$189
- Optional Hold Open Arm: add \$45
- Optional Strike Jamb Reinforcement: add \$90

